



Switch Mode Li-Ion/Polymer Battery Charger

DESCRIPTION

The EUP8202 is a constant current, constant voltage Li-Ion battery charger controller that uses a current mode PWM step-down (buck) switching architecture. With a 500kHz switching frequency, the EUP8202 provides a small, simple and efficient solution to fast charge one (4.2V) or two (8.4V) cell lithium-ion batteries.

The EUP8202 charges the battery in three phases: conditioning, constant current, and constant voltage. An external sense resistor sets the charge current with $\pm 10\%$ accuracy. An internal resistor divider and precision reference set the final float voltage to 4.2V per cell with $\pm 1\%$ accuracy. An internal comparator detects the near end-of-charge condition while an internal timer sets the total charge time and terminates the charge cycle. The EUP8202 automatically re-starts the charge if the battery voltage falls below an internal threshold, 4.05V per cell. The EUP8202 also automatically enters sleep mode when DC supplies are removed.

The EUP8202 is available in the 8-lead SOP and 10-lead TDFN packages.

FEATURES

- Wide Input Supply Voltage Range:
 - 4.7V to 20V – 4.2 Version
 - 8.9V to 20V – 8.4A Version
- 500kHz Switching Frequency
- End-of-Charge Current Detection Output
- 3 Hour Charge Termination Timer
- $\pm 1\%$ Charge Voltage Accuracy
- $\pm 10\%$ Charge Current Accuracy
- Low 10 μ A Reverse Battery Drain Current
- Automatic Battery Recharge
- Automatic Trickle Charging of Low Voltage Batteries
- Automatic Sleep Mode for Low Power Consumption
- Battery Temperature Sensing
- Stable with Ceramic Output Capacitor
- 8-Lead SOP and 10-Lead TDFN Packages
- RoHS Compliant and 100% Lead (Pb)-Free



APPLICATIONS

- Small Notebook Computer
- Portable DVD
- Handheld Instruments

Typical Operating Performance

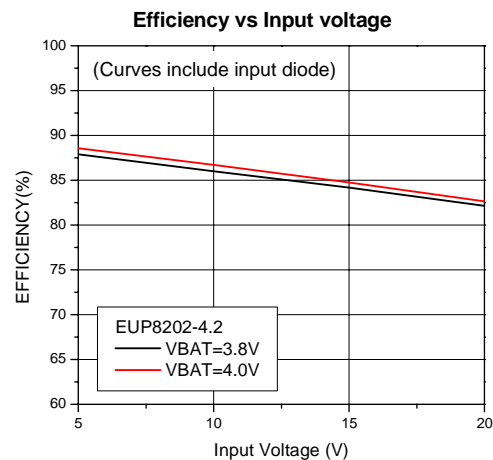
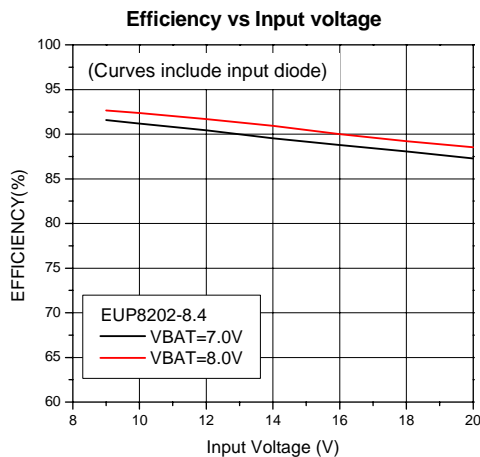

Typical Application Circuit

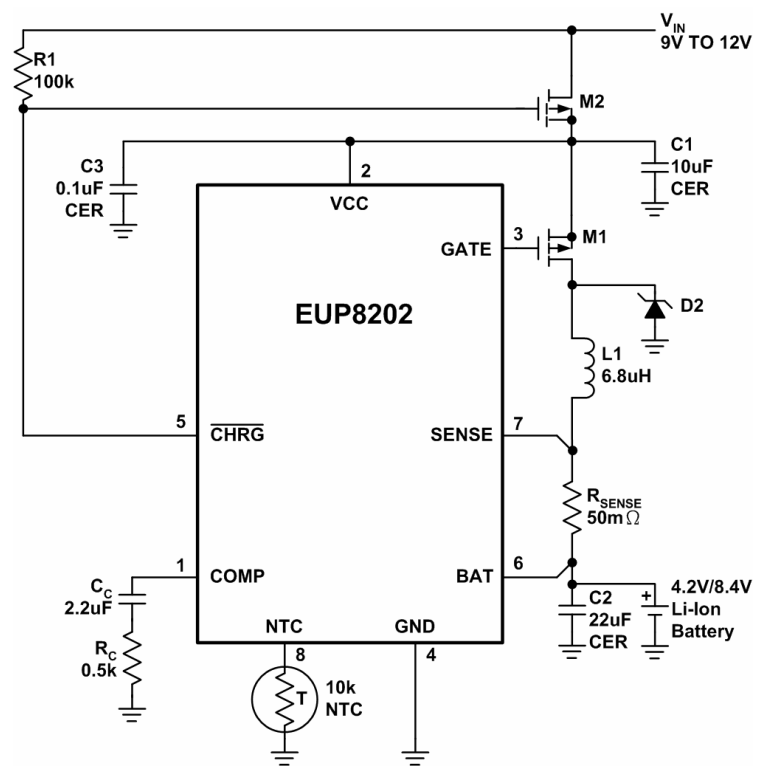

Figure 1. 2A Single/Dual Cells Li-Ion Battery Charger

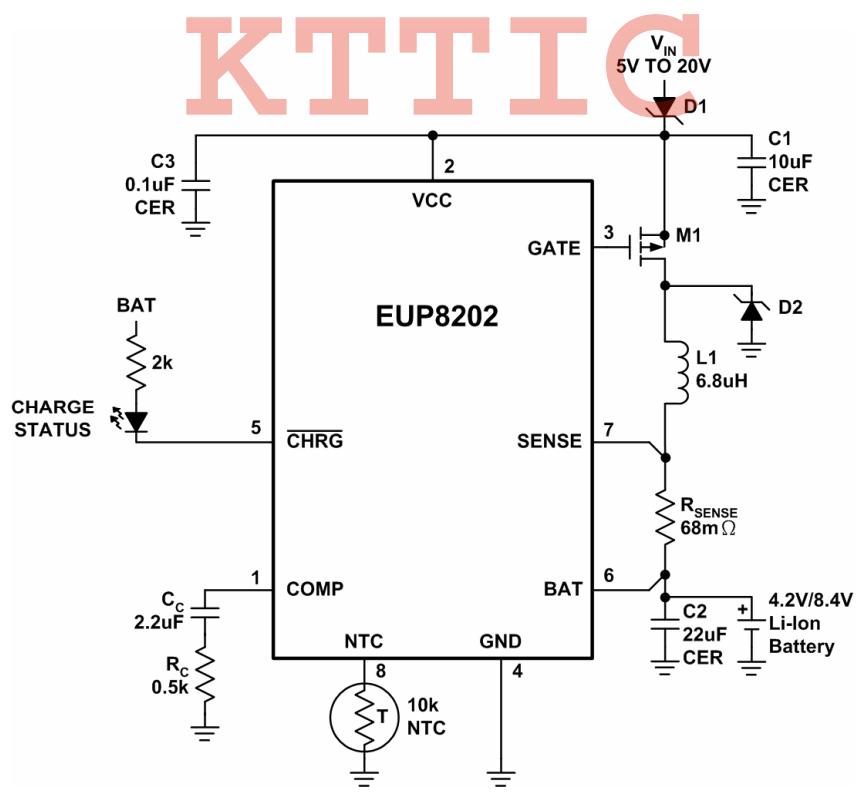

Figure 2. 1.5A Single/Dual Cells Li-Ion Battery Charger



Pin Configurations

Package Type	Pin Configurations	Package Type	Pin Configurations
TDFN-10		SOP-8	<p>(Top View)</p>

Pin Description

PIN	TDFN-10	SOP-8	DESCRIPTION
COMP	1	1	Compensation, Soft-Start and Shutdown Control Pin. Charging begins when the COMP pin reaches 850mV. The recommended compensation components are a 2.2μF (or larger) capacitor and a 0.5k series resistor. A 100μA current into the compensation capacitor also sets the soft-start slew rate. Pulling the COMP pin below 280mV will shut down the charger.
V _{CC}	2	2	Positive Supply Voltage Input.
GATE	3	3	Gate Drive Output. Driver Output for the external P-Channel MOSFET. The voltage at this pin is internally clamped to 8V below V _{CC} , allowing a low voltage MOSFET with gate-to-source breakdown voltage of 8V or less to be used.
PGND	4	-	IC Ground.
SGND	5	-	
GND	-	4	
CHRG	6	5	Charge Status Output.
BAT	7	6	Battery Sense Input. A bypass capacitor of 22μF is required to minimize ripple voltage. When V _{BAT} is within 250mV of V _{CC} , the EUP8202 is forced into sleep mode, dropping I _{CC} to 10μA.
SENSE	8	7	Current Amplifier Sense Input. A sense resistor, R _{SENSE} , must be connected between the SENSE and BAT pins. The maximum charge current is equal to 100mV/R _{SENSE} .
NTC	9	8	NTC (Negative Temperature Coefficient) Thermistor Input. With an external 10kΩ NTC thermistor to ground, this pin senses the temperature of the battery pack and stops the charger when the temperature is out of range. To disable the temperature qualification function, ground the NTC pin.
NC	10	-	No Connect.

Ordering Information

Order Number	Package Type	Marking	Operating Temperature range
EUP8202-42JIR1	TDFN-10	XXXXX P8202 1N	-40 °C to 85°C
EUP8202-84AJIR1	TDFN-10	XXXXX P8202 1PA	-40 °C to 85°C
EUP8202-42DIR1	SOP-8	 XXXXX P8202 1N	-40 °C to 85°C
EUP8202-84ADIR1	SOP-8	 XXXXX P8202 1PA	-40 °C to 85°C

EUP8202-

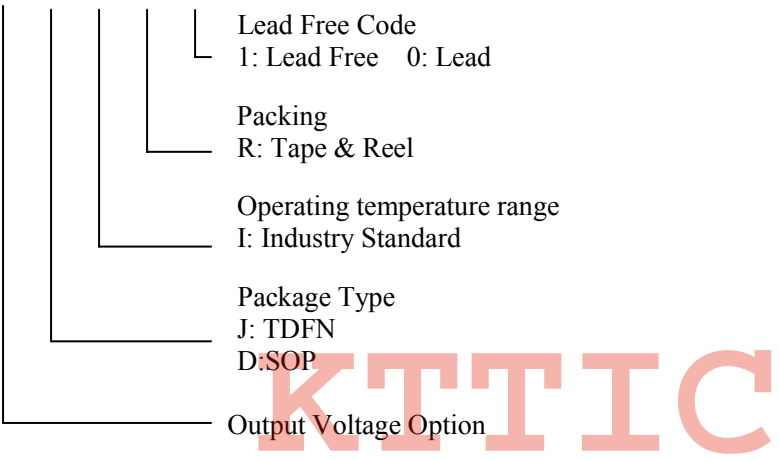

Absolute Maximum Ratings

- Supply Voltage (Vcc) ----- 22V
- GATE ----- (Vcc-8V) to Vcc
- BAT, SENSE ----- -0.3V to 14V
- $\overline{\text{CHRG}}$, NTC ----- -0.3V to 8V
- Operating Temperature Range ----- -40 to 85
- Storage Temperature Range ----- -65 to 125
- Lead Temperature (Soldering, 10sec) ----- 260

Electrical Characteristics ($T_A = 25^\circ\text{C}$, $V_{CC} = 10\text{V}$, unless otherwise noted.)

Symbol	Parameter	Conditions	EUP8202-4.2			Unit	
			Min.	Typ.	Max.		
DC Characteristics							
V_{CC}	V_{CC} Supply Voltage		4.7		20	V	
I_{CC}	V_{CC} Supply Current	Current Mode		1.5	5	mA	
		Shutdown Mode		1.5	5	mA	
		Sleep Mode		10	20	μA	
$V_{\text{BAT(FLT)}}$	Battery Regulated Float Voltage	$5\text{V} \leq V_{CC} \leq 20\text{V}$	4.158	4.2	4.242	V	
$V_{\text{SNS(CHG)}}$	Constant Current Sense Voltage	$3\text{V} \leq V_{\text{BAT}} \leq 4\text{V}$	$T_A = 25$	90	100	110	mV
			$-40 \leq T_A \leq 85$	85		115	
$V_{\text{SNS(TRKL)}}$	Trickle Current Sense Voltage	$V_{\text{BAT}} = 1\text{V}$	8	15	22	mV	
V_{TRKL}	Trickle Charge Threshold Voltage	$V_{\text{BAT}} = \text{Rising}$	2.75	2.9	3.05	V	
V_{UV}	V_{CC} Undervoltage Lockout Threshold Voltage	$V_{CC} = \text{Rising}$	3.9	4.2	4.5	V	
ΔV_{UV}	V_{CC} Undervoltage Lockout Hysteresis Voltage			200		mV	
V_{MSD}	Manual shutdown Threshold Voltage	COMP Pin Falling	150	280	450	mV	
V_{ASD}	Automatic shutdown Threshold Voltage	$V_{CC} - V_{\text{BAT}}$		250		mV	
I_{COMP}	COMP Pin Output Current	$V_{\text{COMP}} = 1.2\text{V}$		100		μA	
I_{CHRG}	$\overline{\text{CHRG}}$ Pin Weak Pull-Down Current	$V_{\text{CHRG}} = 1\text{V}$	15	25	35	μA	
V_{CHRG}	$\overline{\text{CHRG}}$ Pin Output Low Voltage	$I_{\text{CHRG}} = 1\text{mA}$		20	50	mV	
R_{EOC}	End-of-Charge Ratio	$V_{\text{SNS(EOC)}} / V_{\text{SNS(CHG)}}$	10	25	32	%	
t_{TIMER}	Charge time Accuracy				10	%	
I_{NTC}	NTC Pin Output Current	$V_{\text{NTC}} = 0.85\text{V}$	75	85	95	μA	
$V_{\text{NTC-HOT}}$	NTC Pin Thershold Voltage (Hot)	$V_{\text{NTC}} = \text{Falling}$	340	360	380	mV	
		Hysteresis		5		mV	

Electrical Characteristics ($T_A = 25^\circ\text{C}$, $V_{CC} = 10\text{V}$, unless otherwise noted.)

Symbol	Parameter	Conditions	EUP8202-4.2			Unit
			Min.	Typ.	Max.	
$V_{\text{NTC-COLD}}$	NTC Pin Threshold Voltage (Cold)	$V_{\text{NTC}} = \text{Rising}$	2.35	2.4	2.45	V
		Hysteresis		100		mV
ΔV_{RECHRG}	Recharge Battery Voltage Offset from Full Charged Battery Voltage	$V_{\text{BAT(FULLCHARGD)}} - V_{\text{RECHRG}}$, V_{BAT} Falling	100	150	200	mV
I_{LEAK}	$\overline{\text{CHRG}}$ Pin Leakage Current	$V_{\text{CHRG}} = 8\text{V}$, Charging Stops			1	μA
Oscillator						
f_{OSC}	Switching Frequency		450	500	550	kHz
DC	Maximum Duty Cycle				100	%
Gate Drive						
t_r	Rise Time	$C_{\text{GATE}} = 2000\text{pF}$, 10% to 90%		20		ns
t_f	Fall Time	$C_{\text{GATE}} = 2000\text{pF}$, 10% to 90%		50		ns
ΔV_{GATE}	Output Clamp Voltage	$V_{CC} - V_{\text{GATE}}$, $V_{CC} = 9\text{V}$			8	V
ΔV_{GATEHI}	Output High Voltage	$\Delta V_{\text{GATEHI}} = V_{CC} - V_{\text{GATE}}$, $V_{CC} = 7\text{V}$			0.3	V
ΔV_{GATELO}	Output Low Voltage	$\Delta V_{\text{GATELO}} = V_{CC} - V_{\text{GATE}}$, $V_{CC} = 7\text{V}$	4.5			V

Electrical Characteristics ($T_A = 25^\circ\text{C}$, $V_{CC} = 12\text{V}$, unless otherwise noted.)

Symbol	Parameter	Conditions	EUP8202-8.4A			Unit
			Min.	Typ.	Max.	
DC Characteristics						
V_{CC}	V_{CC} Supply Voltage		8.9		20	V
I_{CC}	V_{CC} Supply Current	Current Mode		1.5	5	mA
		Shutdown Mode		1.5	5	mA
		Sleep Mode		10	20	μA
$V_{\text{BAT(FLT)}}$	Battery Regulated Float Voltage	$9\text{V} < V_{CC} < 20\text{V}$	8.257	8.34	8.423	V
$V_{\text{SNS(CHG)}}$	Constant Current Sense Voltage	$6\text{V} < V_{\text{BAT}} < 8\text{V}$, $T_A = 25^\circ\text{C}$	90	100	110	mV
		$-40^\circ\text{C} < T_A < 85^\circ\text{C}$	85		115	
$V_{\text{SNS(TRKL)}}$	Trickle Current Sense Voltage	$V_{\text{BAT}} = 1\text{V}$	8	15	22	mV
V_{TRKL}	Trickle Charge Threshold Voltage	$V_{\text{BAT}} = \text{Rising}$	4.7	5	5.3	V
V_{UV}	V_{CC} Undervoltage Lockout Threshold Voltage	$V_{CC} = \text{Rising}$		7.5	8.5	V
ΔV_{UV}	V_{CC} Undervoltage Lockout Hysteresis Voltage			500		mV
V_{MSD}	Manual shutdown Threshold Voltage	COMP Pin Falling	150	280	450	mV
V_{ASD}	Automatic shutdown Threshold Voltage	$V_{CC} - V_{\text{BAT}}$		250		mV
I_{COMP}	COMP Pin Output Current	$V_{\text{COMP}} = 1.2\text{V}$		100		μA
I_{CHRG}	$\overline{\text{CHRG}}$ Pin Weak Pull-Down Current	$V_{\text{CHRG}} = 1\text{V}$	15	25	35	μA

Electrical Characteristics ($T_A = 25^\circ\text{C}$, $V_{CC} = 12\text{V}$, unless otherwise noted.)

Symbol	Parameter	Conditions	EUP8202-8.4A			Unit
			Min.	Typ.	Max.	
V_{CHRG}	$\overline{\text{CHRG}}$ Pin Output Low Voltage	$I_{\text{CHRG}} = 1\text{mA}$		20	50	mV
R_{EOC}	End-of-Charge Ratio	$V_{\text{SNS(EOC)}} / V_{\text{SNS(CHG)}}$	5	15	25	%
t_{TIMER}	Charge time Accuracy				10	%
I_{NTC}	NTC Pin Output Current	$V_{\text{NTC}} = 0.85\text{V}$	75	85	95	μA
$V_{\text{NTC-HOT}}$	NTC Pin Thershold Voltage (Hot)	$V_{\text{NTC}} = \text{Falling}$	340	360	380	mV
		Hysteresis		5		mV
$V_{\text{NTC-COLD}}$	NTC Pin Thershold Voltage (Cold)	$V_{\text{NTC}} = \text{Rising}$	2.35	2.4	2.45	V
		Hysteresis		100		mV
ΔV_{RECHRG}	Recharge Battery Voltage Offset from Full Charged Battery Voltage	$V_{\text{BAT(FULLCHARGD)}} - V_{\text{RECHRG}}, V_{\text{BAT}}$ Falling	200	300	400	mV
I_{LEAK}	$\overline{\text{CHRG}}$ Pin Leakage Current	$V_{\text{CHRG}} = 8\text{V}$, Charging Stops			1	μA
Oscillator						
f_{OSC}	Switching Frequency		450	500	550	kHz
DC	Maximum Duty Cycle				100	%
Gate Drive						
t_r	Rise Time	$C_{\text{GATE}} = 2000\text{pF}$, 10% to 90%		20		ns
t_f	Fall Time	$C_{\text{GATE}} = 2000\text{pF}$, 10% to 90%		50		ns
ΔV_{GATE}	Output Clamp Voltage	$V_{\text{CC}} - V_{\text{GATE}}, V_{\text{CC}} = 9\text{V}$			8	V
ΔV_{GATEHI}	Output High Voltage	$\Delta V_{\text{GATEHI}} = V_{\text{CC}} - V_{\text{GATE}}, V_{\text{CC}} = 7\text{V}$			0.3	V
ΔV_{GATELO}	Output Low Voltage	$\Delta V_{\text{GATELO}} = V_{\text{CC}} - V_{\text{GATE}}, V_{\text{CC}} = 7\text{V}$	4.5			V

Typical Operating Characteristics

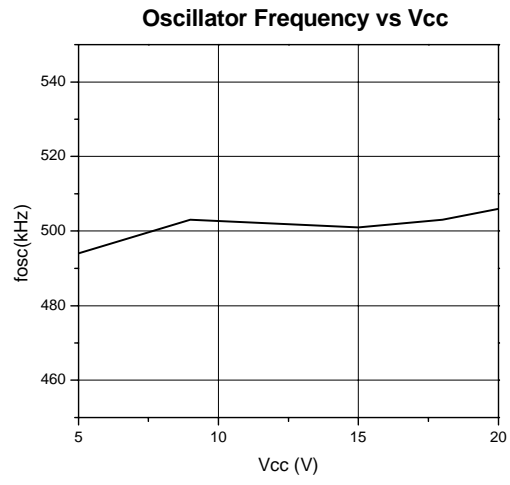
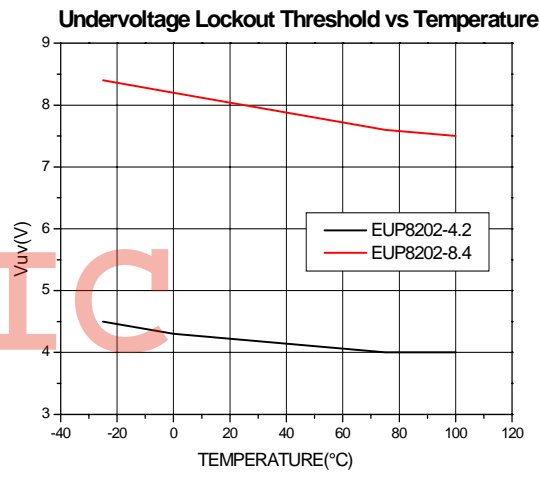
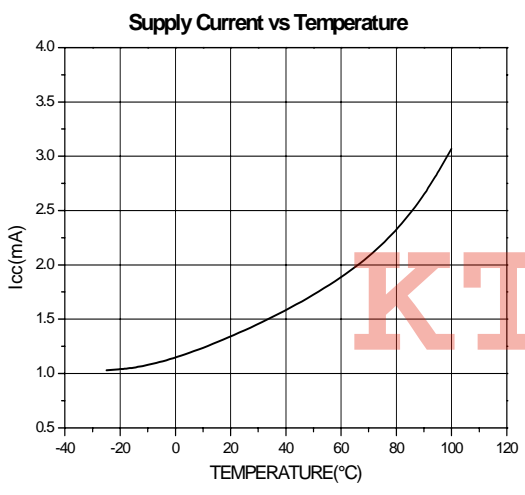
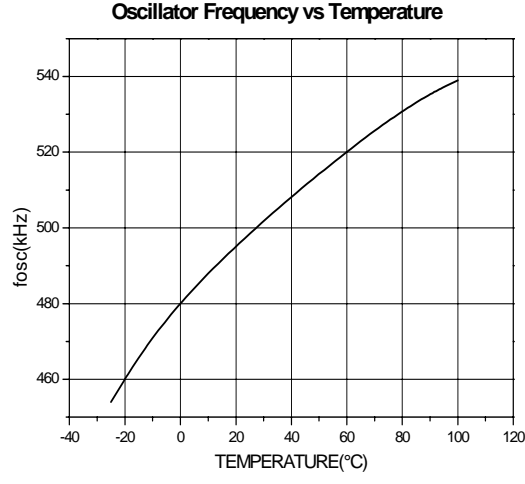
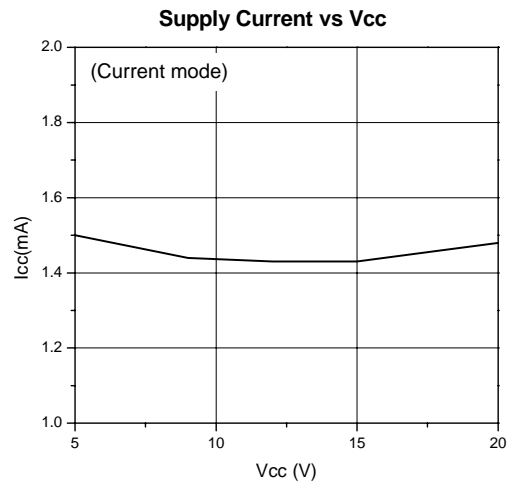

Typical Operating Characteristics (continued)

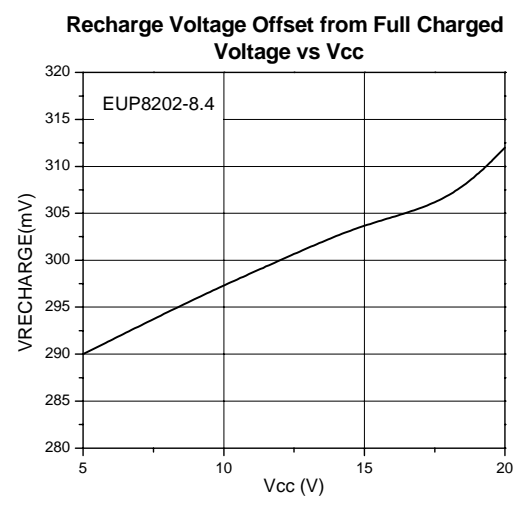
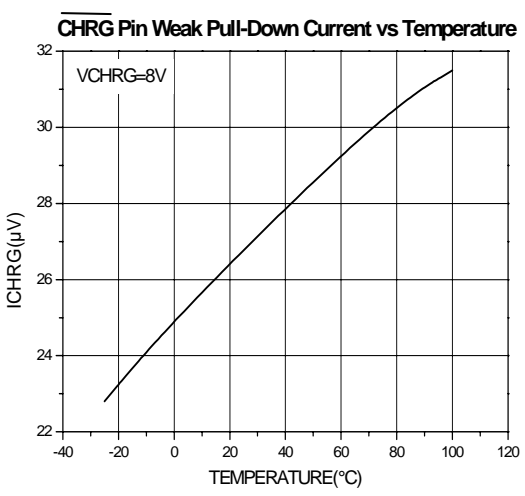
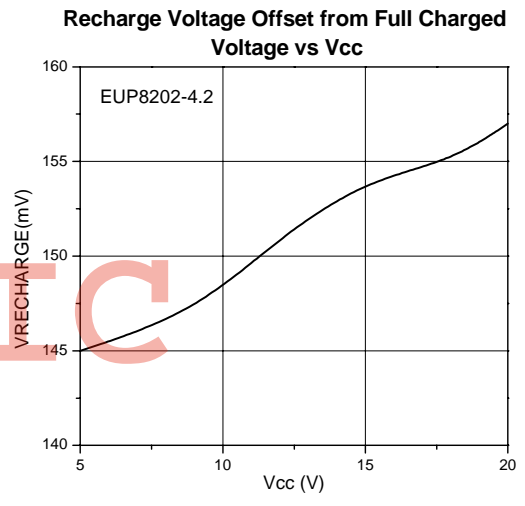
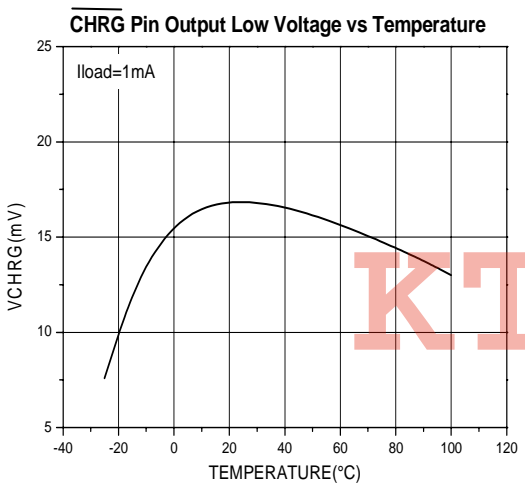
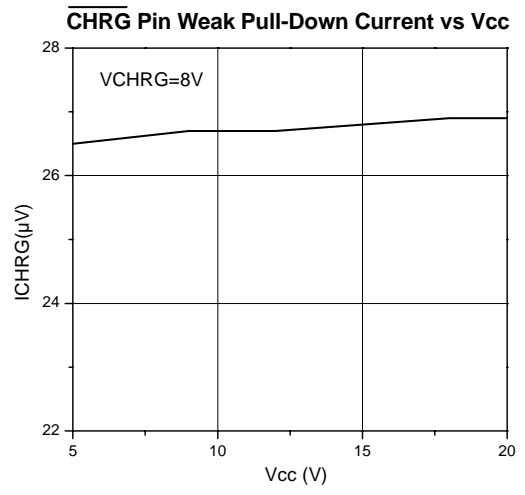
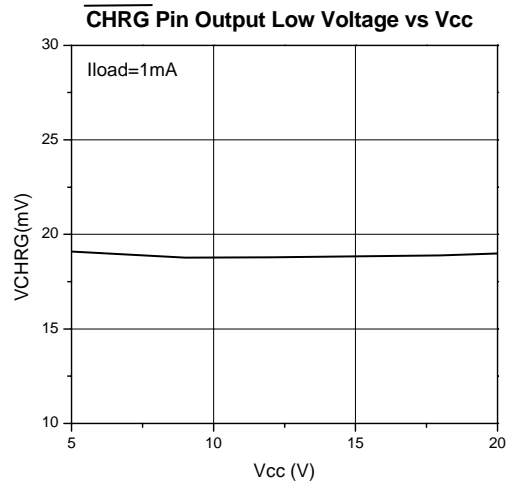

Typical Operating Characteristics (continued)

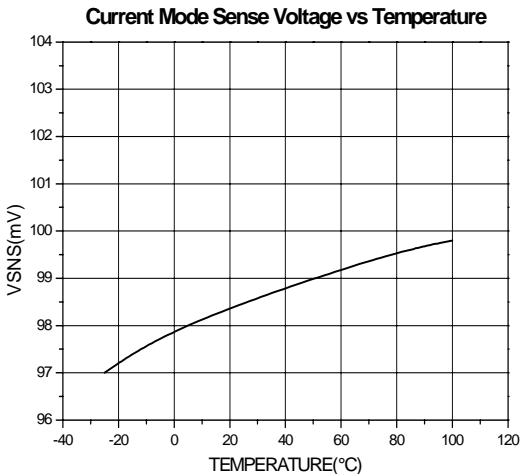
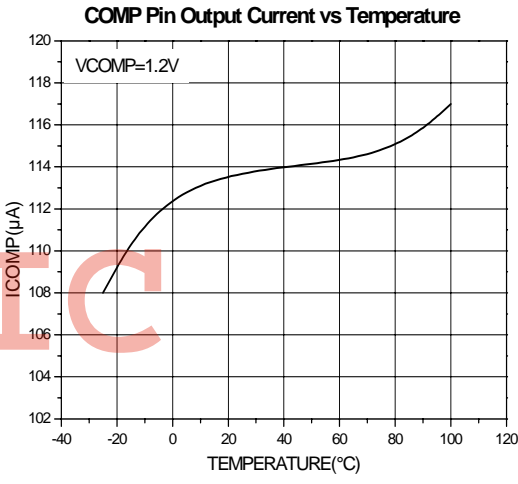
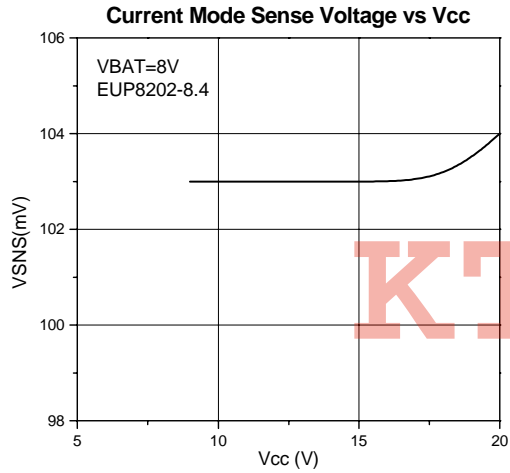
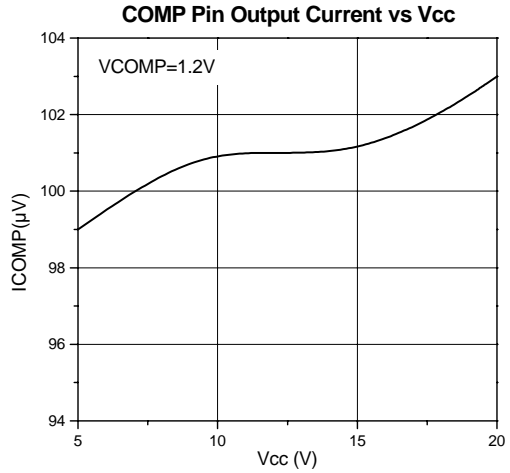
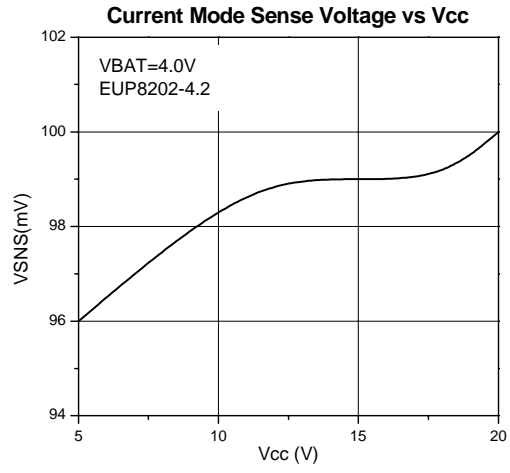

Typical Operating Characteristics (continued)

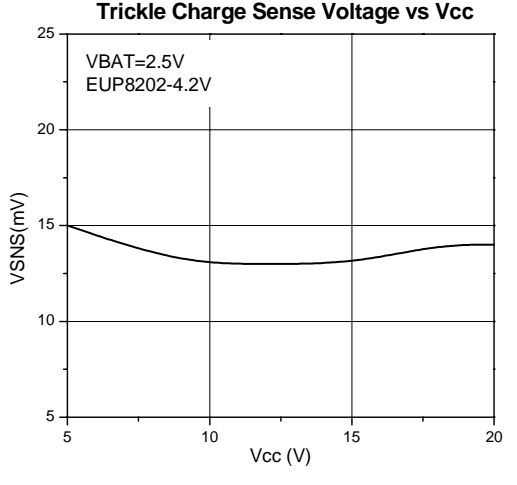
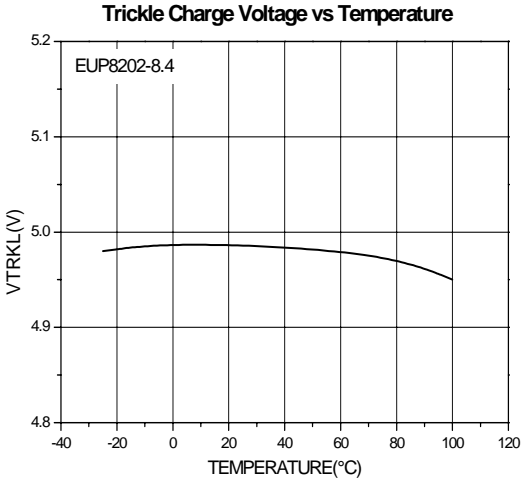
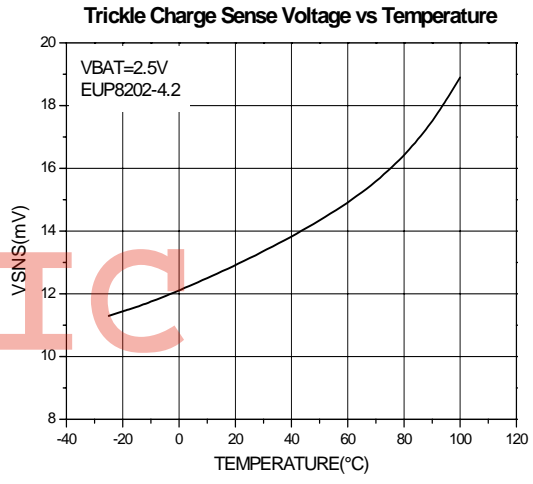
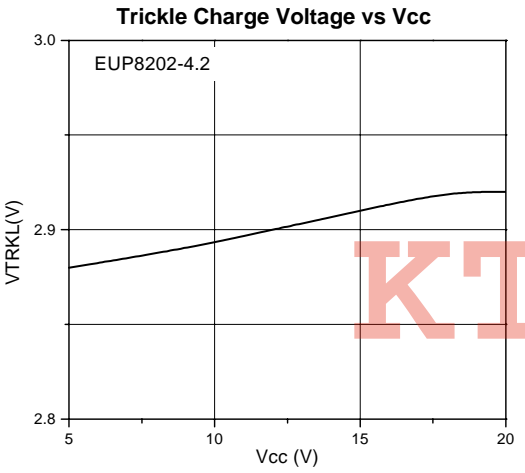
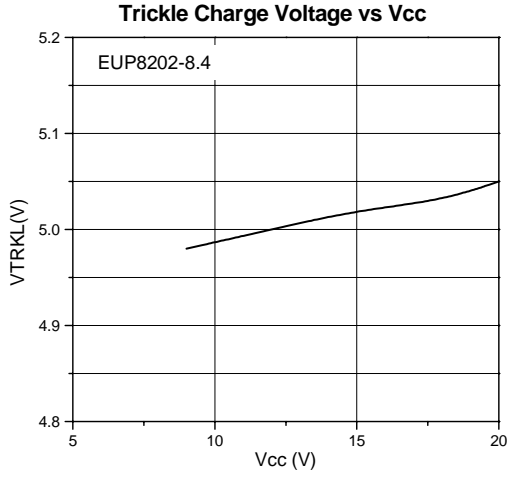
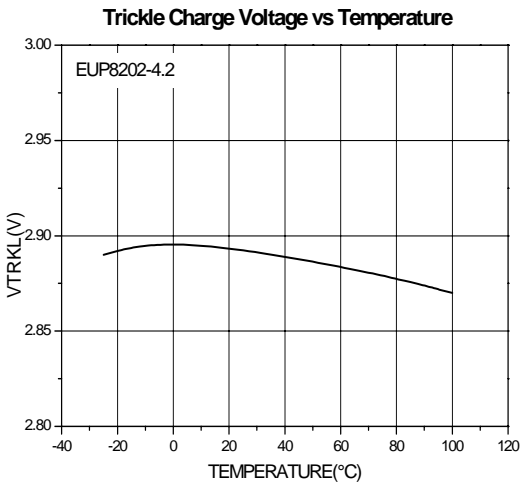

Typical Operating Characteristics (continued)

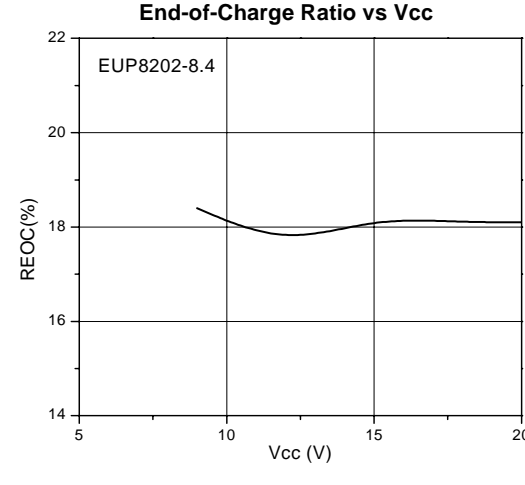
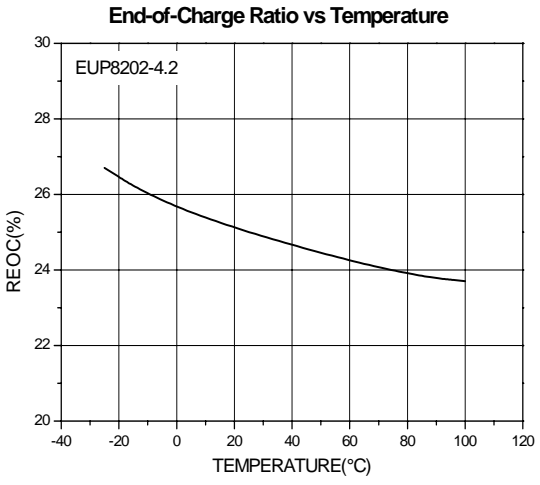
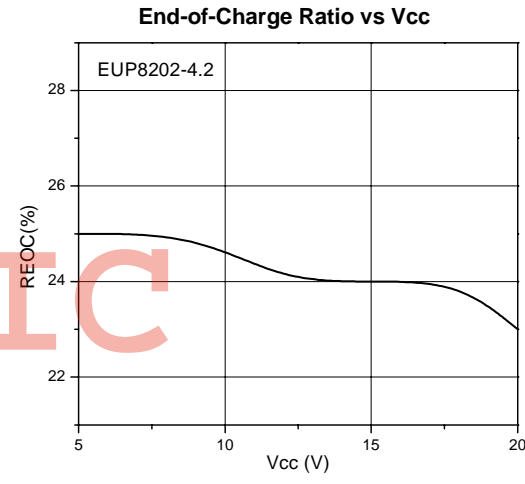
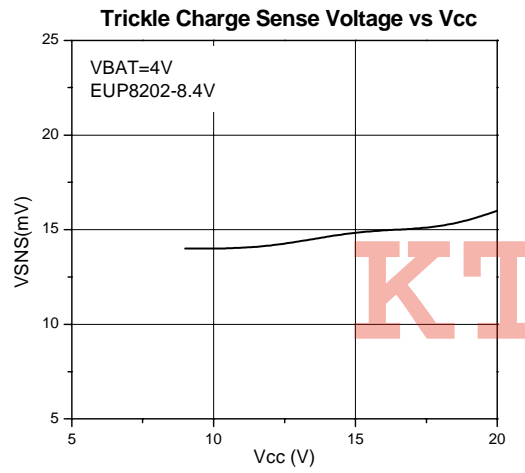
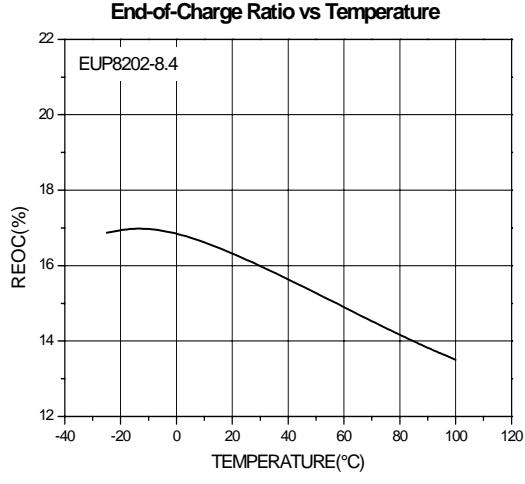
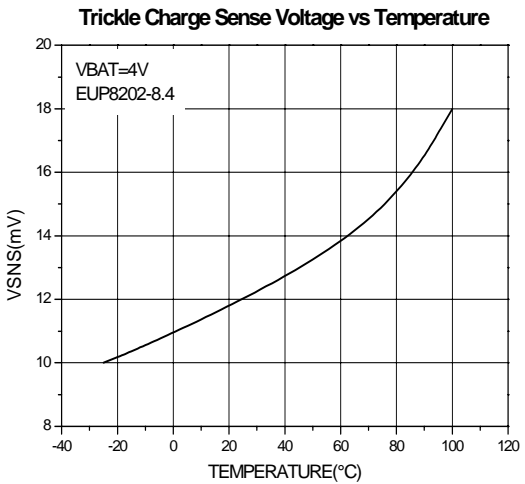

Typical Operating Characteristics (continued)

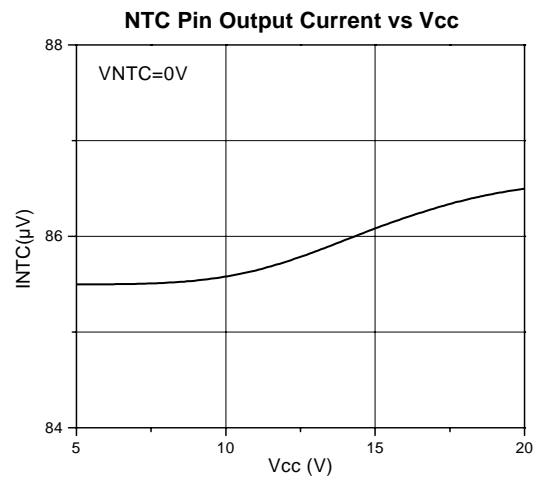
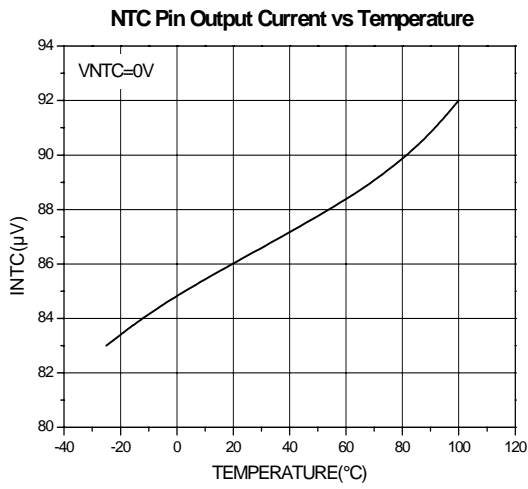

KTTIC

Application Information

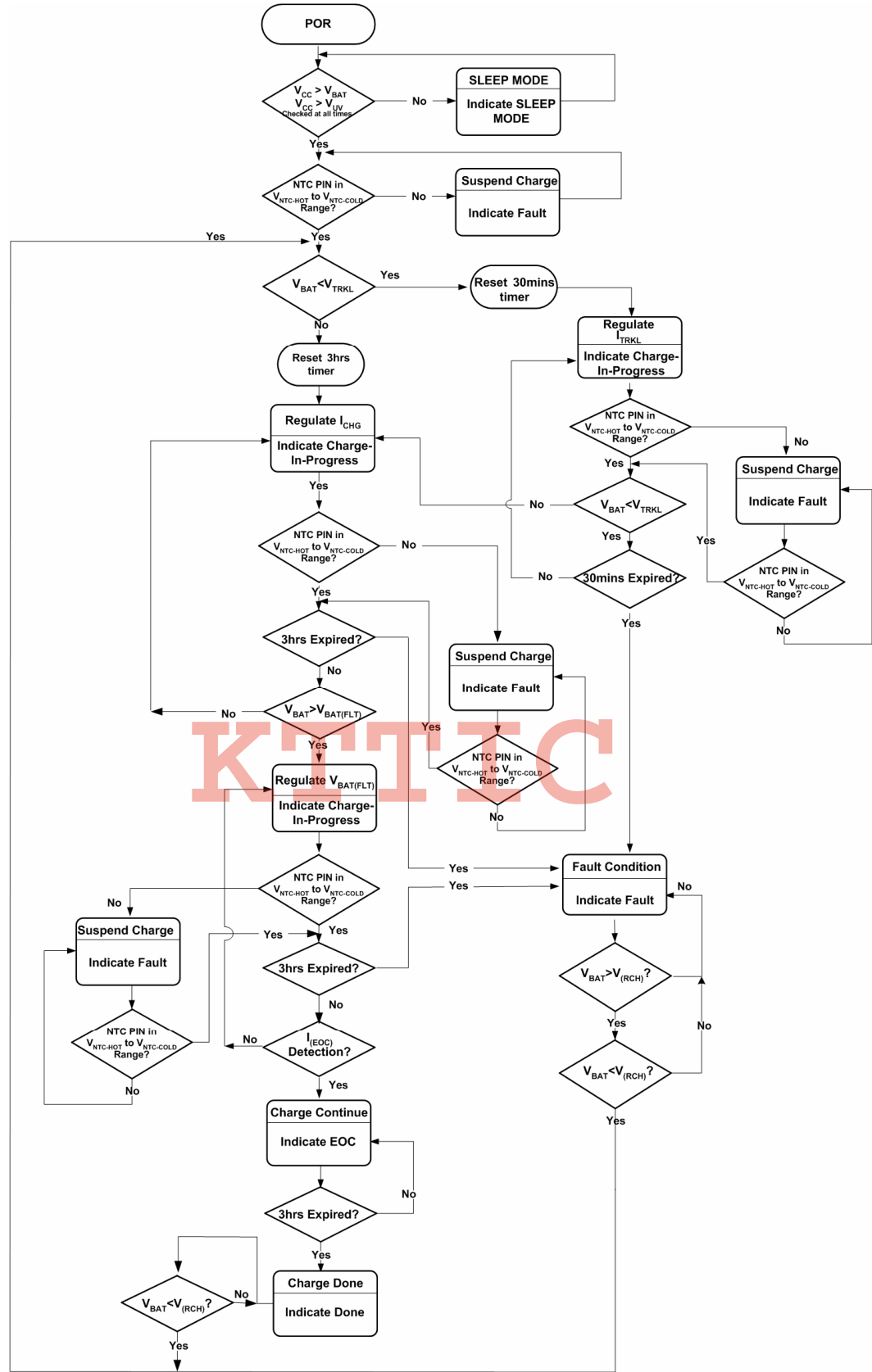

Figure 4. Operational Flow Chart

OPERATION

The EUP8202 is a constant current, constant voltage Li-Ion battery charger controller that uses a current mode PWM step-down (buck) switching architecture. The charge current is set by an external sense resistor (R_{SENSE}) across the SENSE and BAT pins. The final battery float voltage is internally set to 4.2V per cell. For batteries like lithium-ion that require accurate final float voltage, the internal 2.4V reference, voltage amplifier and the resistor divider provide regulation with $\pm 1\%$ accuracy.

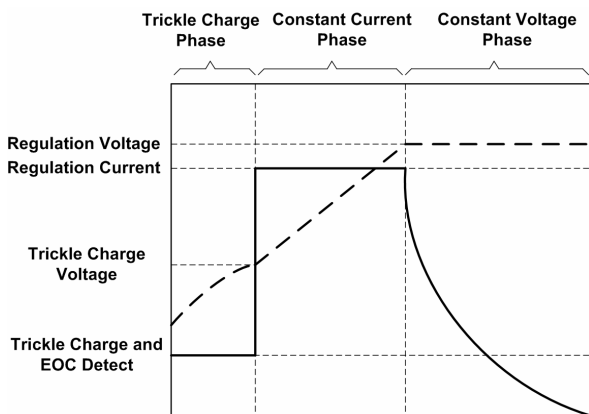

Figure 5. Typical Charge Profile

A charge cycle begins when the voltage at the V_{CC} pin rises above the UVLO level and is 250mV or more greater than the battery voltage. At the beginning of the charge cycle, if the battery voltage is less than the trickle charge threshold, 2.9V for the 4.2 version and 5V for the 8.4 version, the charger goes into trickle charge mode. The trickle charge current is internally set to 15% of the full-scale current. If the battery voltage stays low for 30 minutes, the battery is considered faulty and the charge cycle is terminated.

When the battery voltage exceeds the trickle charge threshold, the charger goes into the full-scale constant current charge mode. In constant current mode, the charge current is set by the external sense resistor R_{SENSE} and an internal 100mV reference;

$$I_{CHG} = \frac{V_{SNS(CHG)}}{R_{SENSE}} = \frac{100mV}{R_{SENSE}}$$

When the battery voltage approaches the programmed float voltage, the charge current will start to decrease. When the current drops to 25% (4.2 version) or 15% (8.4 version) of the full-scale charge current, an internal comparator turns off the internal pull-down N-channel MOSFET at the \overline{CHRG} pin, and connects a weak current source to ground to indicate a near end-of-charge condition.

An internal 3 hour timer determines the total charge time. After a time out occurs, the charge cycle is terminated

and the \overline{CHRG} pin is forced high impedance. To restart the charge cycle, remove and reapply the input voltage or momentarily shut the charger down. Also, a new charge cycle will begin if the battery voltage drops below the recharge threshold voltage of 4.05V per cell.

When the input voltage is present, the charger can be shut down ($I_{CC} = 1.5mA$) by pulling the COMP pin low. When the input voltage is not present, the charger goes into sleep mode, dropping I_{CC} to $10\mu A$. This will greatly reduce the current drain on the battery and increase the standby time.

A 10k Ω NTC (negative temperature coefficient) thermistor can be connected from the NTC pin to ground for battery temperature qualification. The charge cycle is suspended when the temperature is outside of the 0 $^{\circ}C$ to 50 $^{\circ}C$ window.

APPLICATIONS INFORMATION

Undervoltage Lockout (UVLO)

An undervoltage lockout circuit monitors the input voltage and keeps the charger off until V_{CC} rises above the UVLO threshold (4.2V for the 4.2 version, 7.5V for the 8.4 version) and at least 250mV above the battery voltage. To prevent oscillation around the threshold voltage, the UVLO circuit has 200mV per cell of built-in hysteresis. When specifying minimum input voltage requirements, the voltage drop across the input blocking diode must be added to the minimum V_{CC} supply voltage specification.

Trickle Charge and Defective Battery Detection

At the beginning of a charge cycle, if the battery voltage is below the trickle charge threshold, the charger goes into trickle charge mode with the charge current reduced to 15% of the full-scale current. If the low-battery voltage persists for 30 minutes, the battery is considered defective, the charge cycle is terminated and the \overline{CHRG} pin is forced high impedance.

$$I_{TRKL} = \frac{V_{SNS(TRKL)}}{R_{SENSE}} = \frac{15mV}{R_{SENSE}}$$

Shutdown

The EUP8202 can be shut down by pulling the COMP pin to ground which pulls the GATE pin high turning off the external P-channel MOSFET. When the COMP pin is released, the internal timer is reset and a new charge cycle starts. In shutdown, the output of the \overline{CHRG} pin is high impedance and the quiescent current remains at 1.5mA. Removing the input power supply will put the charger into sleep mode. If the voltage at the V_{CC} pin drops below ($V_{BAT} + 250mV$) or below the UVLO level, the EUP8202 goes into a low current ($I_{CC} = 10\mu A$) sleep mode, reducing the battery drain current.

CHRG Status Output Pin

When a charge cycle starts, the $\overline{\text{CHRG}}$ pin is pulled to ground by an internal N-channel MOSFET which is capable of driving an LED. When the charge current drops below the End-of-Charge threshold for more than 120 μs , the N-channel MOSFET turns off and a weak 25 μA current source to ground is connected to the $\overline{\text{CHRG}}$ pin. This weak 25 μA pull-down remains until the timer ends the charge cycle, or the charger is in manual shutdown or sleep mode.

Table1: $\overline{\text{CHRG}}$ Status Pin Summary

CHARGE STATE	$\overline{\text{CHRG}}$ Pin
Trickle Charge in Process	Strong On
Constant Current Charge in Process	Strong On
Constant Voltage Charge in Process	Strong On
Charge Suspend (Temperature)	Strong On (remains the same)
Timer Fault	Hi-Z
Sleep / Shutdown	Hi-Z
End of Charge	Weak On
Battery Disconnected	Weak On

After a time out occurs (charge cycle ends), the pin will become high impedance. By using two different value resistors, a microprocessor can detect three states from this pin (charging, end-of-charge and charging stopped) see Figure 6.

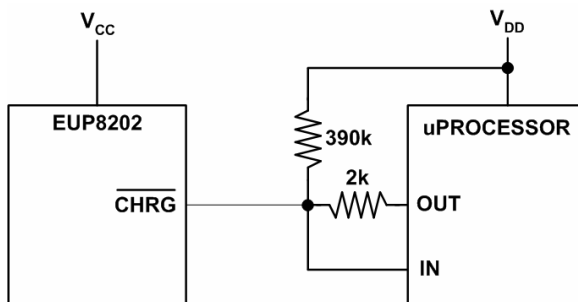

Figure 6. Microprocessor Interface

To detect the charge mode, force the digital output pin, OUT, high and measure the voltage at the $\overline{\text{CHRG}}$ pin. The N-channel MOSFET will pull the pin low even with a 2k pull-up resistor. Once the charge current drops below the End-of-Charge threshold, the N-channel MOSFET is turned off and a 25 μA current source is connected to the $\overline{\text{CHRG}}$ pin. The IN pin will then be pulled high by the 2k resistor connected to OUT. Now force the OUT pin into a high impedance state, the current source will pull the pin low through the 390k resistor. When the internal timer has expired, the $\overline{\text{CHRG}}$

pin changes to a high impedance state and the 390k resistor will then pull the pin high to indicate charging has stopped.

Gate Drive

The EUP8202 gate driver can provide high transient currents to drive the external pass transistor. The rise and fall times are typically 20ns and 50ns respectively when driving a 2000pF load, which is typical for a P-channel MOSFET with $R_{\text{DS(ON)}}$ in the range of 50m Ω .

A voltage clamp is added to limit the gate drive to 8V below V_{CC} . For example, if V_{CC} is 10V then the GATE output will pull down to 2V max. This allows low voltage P-channel MOSFETs with superior $R_{\text{DS(ON)}}$ to be used as the pass transistor thus increasing efficiency.

Stability

Both the current loop and the voltage loop share a common, high impedance, compensation node (COMP pin). A series capacitor and resistor on this pin compensates both loops. The resistor is included to provide a zero in the loop response and boost the phase margin. The compensation capacitor also provides a soft-start function for the charger. Upon start-up, then ramp at a rate set by the internal 100 μA pullup current source and the external capacitor. Battery charge current starts ramping up when the COMP pin voltage reaches 0.85V and full current is achieved with the COMP pin at 1.3V. With a 2.2 μF capacitor, time to reach full charge current is about 10ms. Capacitance can be increased if a longer start-up time is needed.

Automatic Battery Recharge

After the 3 hour charge cycle is completed and both the battery and the input power supply (wall adapter) are still connected, a new charge cycle will begin if the battery voltage drops below 4.05V per cell due to self-discharge or external loading. This will keep the battery capacity at more than 80% at all times without manually restarting the charge cycle.

Battery Temperature Detection

A negative temperature coefficient (NTC) thermistor located close to the battery pack can be used to monitor battery temperature and will not allow charging unless the battery temperature is within an acceptable range.

Connect a 10k Ω thermistor from the NTC pin to ground. If the temperature rises to 50 $^{\circ}\text{C}$, the resistance of the NTC will be approximately 4.2k Ω . With the 85 μA pull-up current source, the Hot temperature voltage threshold is 360mV. For Cold temperature, the voltage threshold is set at 2.4V which is equal to 0 $^{\circ}\text{C}$ ($R_{\text{NTC}} \cong 28\text{k}\Omega$) with 85 μA of pull-up current. If the temperature is outside the window, the GATE pin will be pulled up to V_{CC} and the timer frozen while the output status at the $\overline{\text{CHRG}}$ pin remains the same. The charge cycle begins or resumes once the temperature is within the acceptable

range. Short the NTC pin to ground to disable the temperature qualification feature. However the user may modify these thresholds by adding two external resistor. See figure 8.

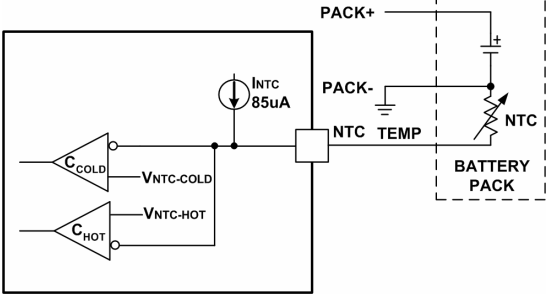

Figure 7. Temperature Sensing Configuration

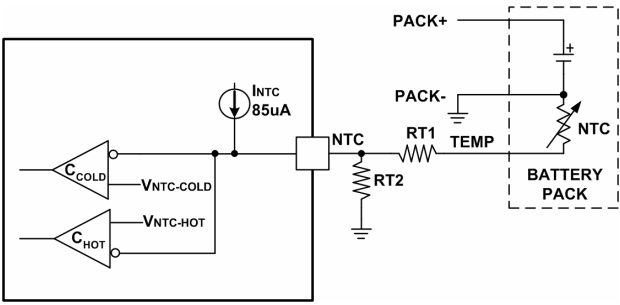

Figure 8. Temperature Sensing Thresholds

Input and Output Capacitors

Since the input capacitor is assumed to absorb all input switching ripple current in the converter, it must have an adequate ripple current rating. Worst-case RMS ripple current is approximately one-half of output charge current. Actual capacitance value is not critical. Solid tantalum capacitors have a high ripple current rating in a relatively small surface mount package, but caution must be used when tantalum capacitors are used for input bypass. High input surge currents can be created when the adapter is hot-plugged to the charger and solid tantalum capacitors have a known failure mechanism when subjected to very high turn-on surge currents. Selecting the highest possible voltage rating on the capacitor will minimize problems. Consult with the manufacturer before use.

The selection of output capacitor C_{OUT} is primarily determined by the ESR required to minimize ripple voltage and load step transients. The output ripple ΔV_{OUT} is approximately bounded by:

$$\Delta V_{OUT} \leq \Delta I_L \left(ESR + \frac{1}{8f_{OSC} C_{OUT}} \right)$$

Since ΔI_L increases with input voltage, the output ripple is highest at maximum input voltage. Typically, once the ESR requirement is satisfied, the capacitance is adequate

for filtering and has the necessary RMS current rating. Switching ripple current splits between the battery and the output capacitor depending on the ESR of the output capacitor and the battery impedance. EMI considerations usually make it desirable to minimize ripple current in the battery leads. Ferrite beads or an inductor may be added to increase battery impedance at the 500kHz switching frequency. If the ESR of the output capacitor is 0.2Ω and the battery impedance is raised to 4Ω with a bead or inductor, only 5% of the current ripple will flow in the battery.

Design Example

As a design example, take a charger with the following specifications:

For single cell charge, V_{IN} = 5V to 20V, V_{BAT} = 4V nominal, I_{BAT} = 1.5A, f_{OSC} = 500kHz, I_{EOC} = 0.375A, see Figure 2.

First, calculate the SENSE resistor :

$$R_{SENSE} = \frac{100mV}{1.5A} = 68m\Omega$$

Choose the inductor for about 65% ripple current at the maximum V_{IN}:

$$L = \frac{4V}{(500kHz)(0.65)(1.5A)} \left(1 - \frac{4V}{20V} \right) = 6.56\mu H$$

Selecting a standard value of 6.8μH results in a maximum ripple current of :

$$\Delta I_L = \frac{4V}{(500kHz)(6.8\mu H)} \left(1 - \frac{4V}{20V} \right) = 941.2mA$$

$$I_{LPK} = I_{CHG} + \frac{\Delta I_L}{2} = 1.5A + \frac{941.2mA}{2} \approx 1.975A$$

Next, choose the P-channel MOSFET. For example, a TSSOP-8 package with R_{DS(ON)} = 42mΩ (nom), 55mΩ (max) offers a small solution. The maximum power dissipation with V_{IN} = 5V and V_{BAT} = 4V at 50 ambient temperature is:

$$P_D = \frac{(1.5A)^2 (55m\Omega) (4V)}{5V} = 0.099W$$

$$T_J = 50 + (0.099W)(65 /W) = 56.5$$

C_{IN} is chosen for an RMS current rating of about 0.8A at 85 . The output capacitor is chosen for an ESR similar to the battery impedance of about 100mΩ The ripple voltage on the BAT pin is:



$$V_{\text{OUT(RIPPLE)}} = \frac{\Delta I_{\text{L(max)}}(\text{ESR})}{2}$$

$$= \frac{(0.94\text{A})(0.1\Omega)}{2} = 47\text{mV}$$

For dual cells charge,
 $V_{\text{IN}} = 5\text{V to } 20\text{V}$, $V_{\text{BAT}} = 8\text{V nominal}$, $I_{\text{BAT}} = 3\text{A}$,
 $f_{\text{OSC}} = 500\text{kHz}$, $I_{\text{EOC}} = 0.45\text{A}$,

$$R_{\text{SENSE}} = \frac{100\text{mV}}{3\text{A}} = 33\text{m}\Omega$$

Choose the inductor for about 50% ripple current at the maximum V_{IN} :

$$L = \frac{8\text{V}}{(500\text{kHz})(0.5)(3\text{A})} \left(1 - \frac{8\text{V}}{20\text{V}}\right) = 6.4\mu\text{H}$$

Selecting a standard value of $6.8\mu\text{H}$ results in a maximum ripple current of:

$$\Delta I_{\text{L}} = \frac{8\text{V}}{(500\text{kHz})(6.8\mu\text{H})} \left(1 - \frac{8\text{V}}{20\text{V}}\right) = 1.441\text{A}$$

$$I_{\text{LPK}} = I_{\text{CHG}} + \frac{\Delta I_{\text{L}}}{2} = 3\text{A} + \frac{1.441\text{A}}{2} \approx 3.720\text{A}$$

The maximum power dissipation with $V_{\text{IN}} = 9\text{V}$ and $V_{\text{BAT}} = 8\text{V}$ at 50°C ambient temperature is:

$$P_{\text{D}} = \frac{(3\text{A})^2(55\text{m}\Omega)(8\text{V})}{9\text{V}} = 0.44\text{W}$$

$$T_{\text{J}} = 50 + (0.44\text{W})(65^\circ\text{C/W}) = 78.6$$

$$V_{\text{OUT(RIPPLE)}} = \frac{\Delta I_{\text{L(max)}}(\text{ESR})}{2}$$

$$= \frac{(1.441\text{A})(0.1\Omega)}{2} = 72\text{mV}$$

The Schottky diode D2 shown in Figure 2 conducts current when the pass transistor is off. In a low duty cycle case, the current rating should be the same or higher than the charge current. Also it should withstand reverse voltage as high as V_{IN} .

Board Layout Suggestions

When laying out the printed circuit board, the following considerations should be taken to ensure proper operation of the EUP8202.

GATE pin rise and fall times are 20ns and 50ns respectively (with $C_{\text{GATE}} = 2000\text{pF}$). To minimize radiation, the catch diode, pass transistor and the input bypass capacitor traces should be kept as short as possible. The positive side of the input capacitor should be close to the source of the P-channel MOSFET; it provides the AC current to the pass transistor. The connection between the catch diode and the pass transistor should also be kept as short as possible. The SENSE and BAT pins should be connected directly to the sense resistor (Kelvin sensing) for best charge current accuracy. Avoid routing the NTC PC board trace near the MOSFET switch to minimize coupling switching noise into the NTC pin.

The compensation capacitor connected at the COMP pin should return to the ground pin of the IC or as close to it as possible. This will prevent ground noise from disrupting the loop stability. The ground pin also works as a heat sink, therefore use a generous amount of copper around the ground pin. This is especially important for high V_{CC} and/or high gate capacitance applications.

KTTIC

Packaging Information

TDFN-10

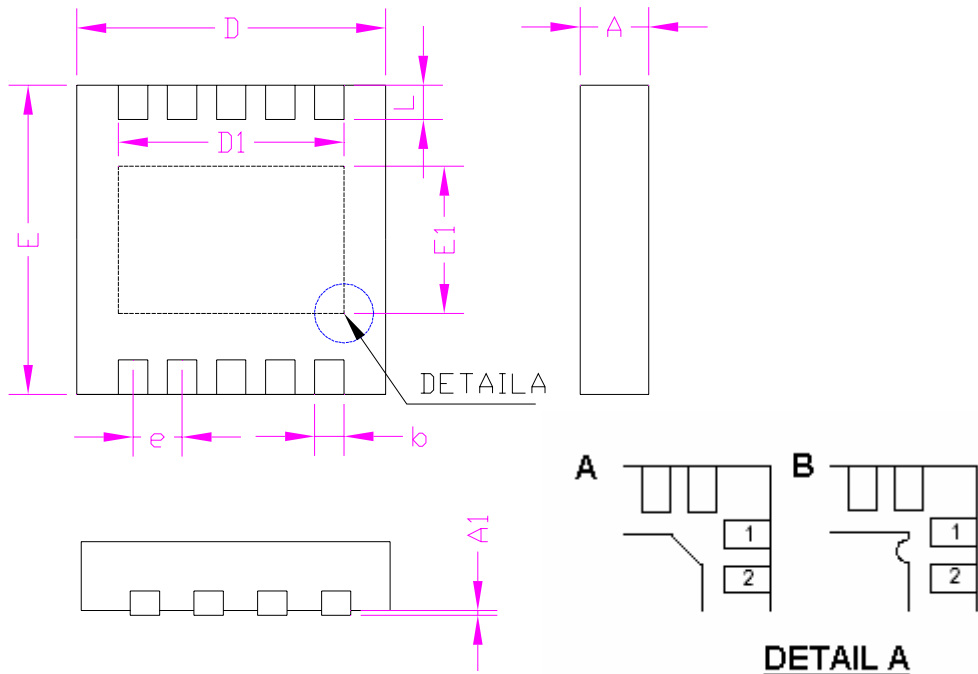

KTTIC

Thermal Pad Option

SYMBOLS	MILLIMETERS		INCHES	
	MIN.	MAX.	MIN.	MAX.
A	0.70	0.80	0.028	0.031
A1	0.00	0.05	0.000	0.002
D	2.90	3.10	0.114	0.122
E1	1.70		0.067	
E	2.90	3.10	0.114	0.122
L	0.30	0.50	0.012	0.020
b	0.18	0.30	0.007	0.012
e	0.50		0.020	
D1	2.40		0.094	

SOP-8

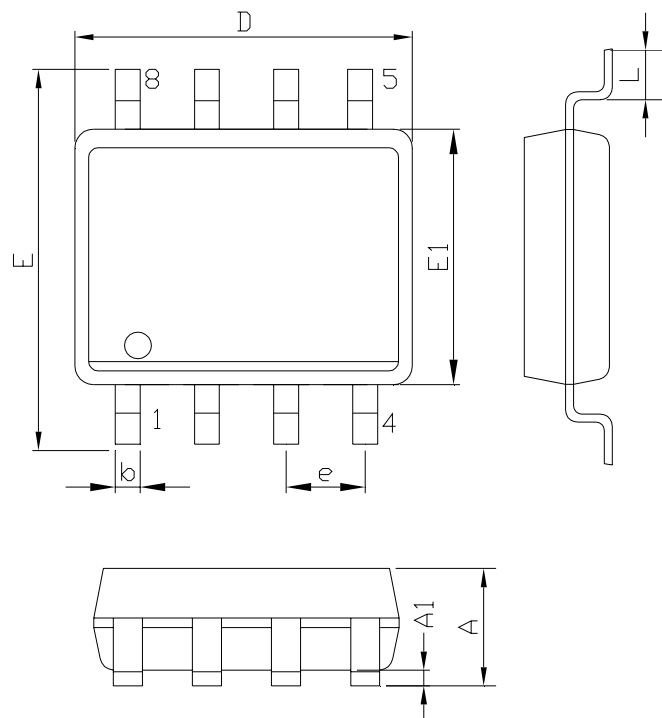

KTTIC

SYMBOLS	MILLIMETERS		INCHES	
	MIN.	MAX.	MIN.	MAX.
A	1.35	1.75	0.053	0.069
A1	0.10	0.25	0.004	0.010
D	4.90		0.193	
E	5.80	6.20	0.228	0.244
E1	3.90		0.153	
L	0.40	1.27	0.016	0.050
b	0.31	0.51	0.012	0.020
e	1.27		0.050	