

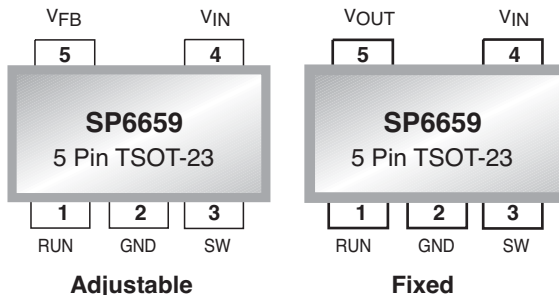

1.5MHz, 600mA Synchronous Buck Regulator

FEATURES

- 94% Efficiency Possible
- 600mA Output Current at $V_{IN} = 3.6V$
- 2.5V to 5.5V Input Voltage Range
- 1.5MHz constant frequency operation
- No Schottky Diode Required
- Output Voltages as low as 0.6V
- Slope Compensated Current Mode Operation for Excellent Line and Load Transient Response
- 100 % Duty Cycle in LDO Mode
- $<1\mu A$ Shutdown Current, Quiescent Current of 300 μA
- Over-temperature protected
- Pin Compatible to LTC3406B
- Offered in Low Profile TSOT-23 package



Now Available in Lead Free Packaging

APPLICATIONS

- Cell Phones
- Wireless and DSL Modems
- DSC's
- Portable Instruments

DESCRIPTION

The SP6659 is a 600mA synchronous buck regulator using a constant frequency, current mode architecture. The output voltage can be programmed using an external resistor divider. The 2.5V to 5.5V input voltage range is ideal for portable applications that use a Li-Ion battery. Switching frequency is internally set at 1.5MHz, allowing the use of small surface mount inductors and capacitors. The internal synchronous switch increases efficiency and eliminates the need for an external Schottky diode. The output voltage can be programmed using an external resistor divider. Low output voltages are easily supported with the 0.6V feedback reference voltage. The SP6659 is available in a low profile 5 pin TSOT-23 package.

TYPICAL APPLICATION SCHEMATICS

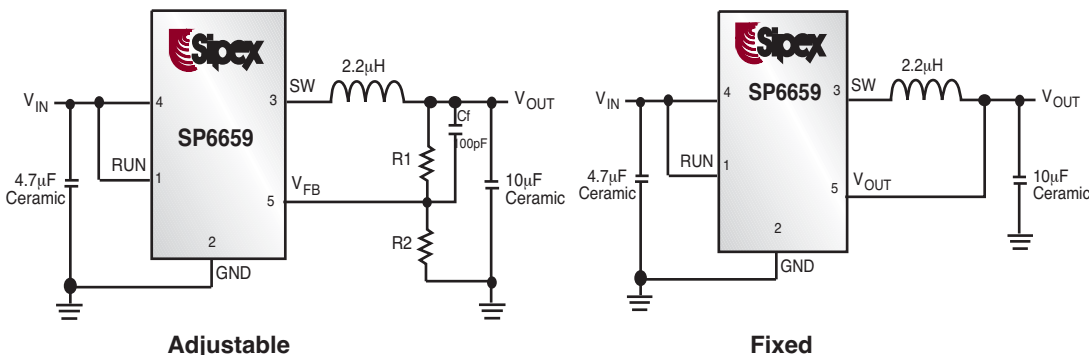

ABSOLUTE MAXIMUM RATINGS

These are stress ratings only and functional operation of the device at these ratings or any other above those indicated in the operation sections of the specifications below is not implied. Exposure to absolute maximum rating conditions for extended periods of time may affect reliability.

Input Supply Voltage	-0.3V to +6V
RUN, V _{FB} Voltages	-0.3V to (V _{IN} + 0.3V)
SW Voltage	-0.3V to (V _{IN} + 0.3V)
P-Channel Switch Source Current (DC)	800mA
N-Channel Switch Sink Current (DC)	800mA
Peak Switch Sink and Source Current	1.3A
Operating Temperature	-40°C to +85°C
Storage Temperature	-65°C to +150°C
Junction Temperature (Note 1)	125°C
Lead Temperature (Soldering, 10 sec)	300°C

THERMAL RESISTANCE

Thermal Resistance is specified with approximately 1 square inch of 1 ounce copper.
 Θ_{JA}207.4°C/W
 Θ_{JC}110°C/W

ELECTRICAL CHARACTERISTICS

V_{IN} = V_{RUN} = 3.6V, I_o = 0mA, T_{AMB} = -40°C to +85°C, typical values at 25°C unless otherwise noted.

The ♦ denotes the specifications which apply over the full operating temperature range, unless otherwise specified.

PARAMETER	MIN	TYP	MAX	UNITS	CONDITIONS
Input Voltage Range	2.5		5.5	V	♦
Input DC Supply Current					
Active Mode		300	400	μA	V _{FB} = 0.5V, V _{IN} = V _{RUN}
Shutdown Mode		0.1	1	μA	V _{IN} = 3.6V, V _{RUN} = 0.0V
V _{FB} (Feedback Voltage)	0.5880	0.6000	0.6120		T _A = +25°C
	0.5865	0.6000	0.6135	V	0°C < T _A < +85°C
	0.5820	0.6000	0.6180		♦ -40°C < T _A < +85°C
V _{FB} Input Bias Current		85	300	nA	V _{FB} = 1.0V
V _{FB} Line Regulation		0.4	1	%/V	♦ V _{IN} = 2.5V to 5.5V
V _{FB} Load Regulation		0.01		%/mA	♦ I _{LOAD} = 0mA to 600mA
Regulated Output Voltage	1.455	1.500	1.545	V	♦ SP6659EK1-1.5, -40°C < T _A < +85°C
	1.746	1.800	1.854	V	♦ SP6659EK1-1.8, -40°C < T _A < +85°C
Minimum Output Voltage	0.6			V	
Peak inductor current	0.7	1.0	1.2	A	V _{FB} = 0.5V, V _{IN} = 2.5V
Oscillator frequency	0.8	1.4	1.8	MHz	♦ Closed Loop, I _{LOAD} = 100mA
P-channel ON resistance		0.4	0.6	Ω	I _{SW} = 100mA
N-channel ON resistance		0.4	0.6	Ω	I _{SW} = -100mA
SW Leakage Current		±0.01	±1.0	μA	V _{IN} = 3.6V, V _{RUN} = 0.0V, V _{sw} = 0.0V, V _{sw} = V _{IN}
Run Threshold Voltage	0.2	1	1.3	V	♦
Run Leakage Current		±0.01	±1.5	μA	♦

Note 1: Junction Temperature T_J is calculated from the ambient temperature T_A and over dissipation P_D according to the following formula: T_J = T_A + P_D X 220°C/W

PIN DESCRIPTION

PIN #	PIN NAME	DESCRIPTION
1	RUN	Power down control pin. Forcing this pin above 1.5V enables the device. Forcing this pin below 0.3V shuts down the device.
2	GND	Ground pin.
3	SW	Switching node.
4	V _{IN}	Power supply pin
5	V _{FB} / V _{OUT}	Adjustable Version: V _{FB} , Feedback Input Pin. Connect FB to the center point of the external resistor divider. The feedback threshold voltage is 0.6V. Fixed Output Version: V _{OUT} , Output Voltage Feedback Pin. An internal resistive divider drops the output voltage down for comparison to the internal reference voltage.

Refer to the typical application schematic, $V_{OUT} = 1.8V$, $T_{AMB} = +27^{\circ}C$

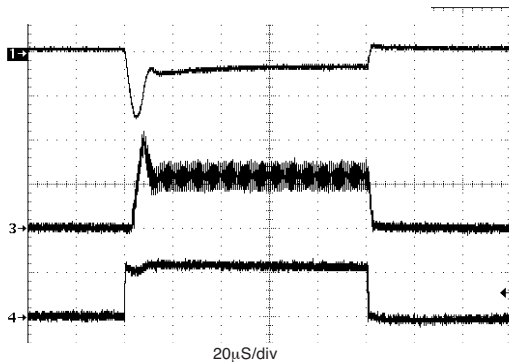

Figure 1: Load Transient 0mA to 600mA

CH 1: Output Voltage, 200mV per division AC-Coupled
 CH 3: Inductor Current, 500mA/ div
 CH 4: Load Current, 500mA/ div

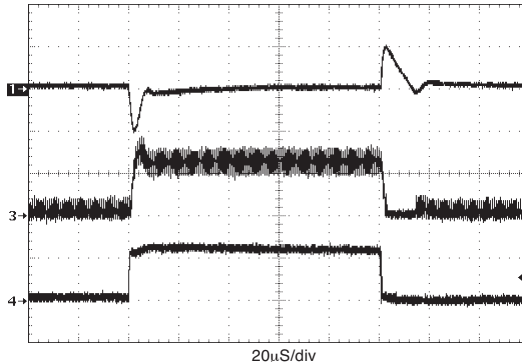

Figure 2: Load Transient 50mA to 600mA

CH 1: Output Voltage, 100mV per division AC-Coupled
 CH 3: Inductor Current, 500mA/ div
 CH 4: Load Current, 500mA/ div

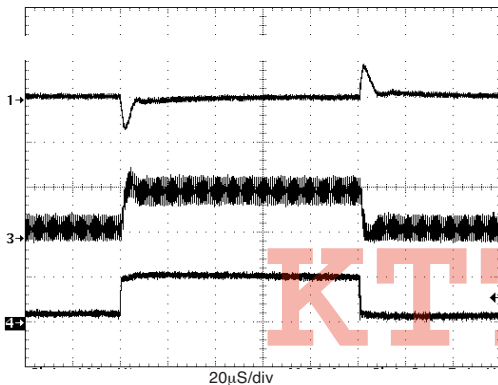

Figure 3: Load Transient 100mA to 600mA

CH 1: Output Voltage, 100mV per division AC-Coupled
 CH 3: Inductor Current, 500mA/ div
 CH 4: Load Current, 500mA/ div

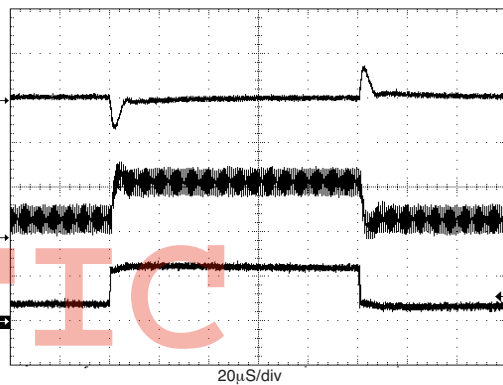

Figure 4: Load Transient 200mA to 600mA

CH 1: Output Voltage, 100mV per division AC-Coupled
 CH 3: Inductor Current, 500mA/ div
 CH 4: Load Current, 500mA/ div

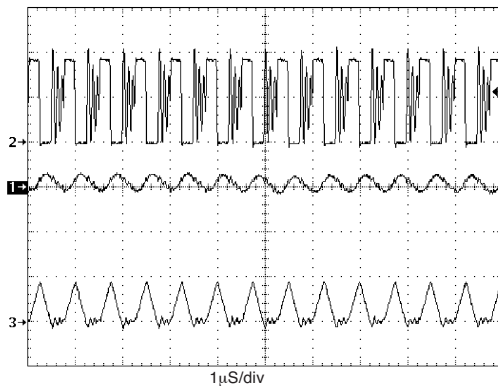

Figure 5: Discontinuous Mode

CH 1: Output Voltage, 10mV per division AC-Coupled
 CH 2: SW 2V/div
 CH 3: Inductor Current, 500mA/ div

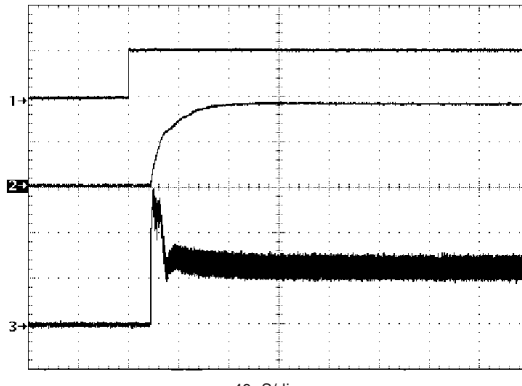

Figure 6: Startup from Shutdown

CH 1: RUN pin 2V/div.
 CH 2: Vout 1V/div
 CH 3: Inductor Current, 500mA/ div

TYPICAL PERFORMANCE CHARACTERISTICS
 Refer to the typical application schematic, $V_{OUT} = 1.8V$, $T_{AMB} = +27^{\circ}C$

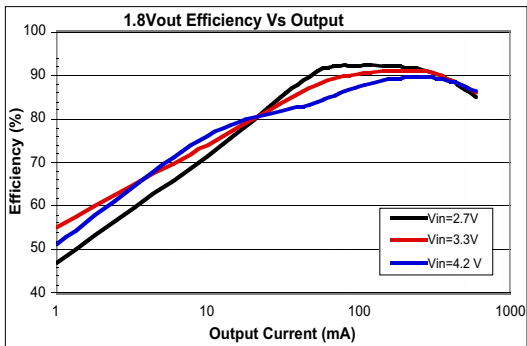

Figure 7: Efficiency Vs. Load Current, $V_{out} = 1.8V$

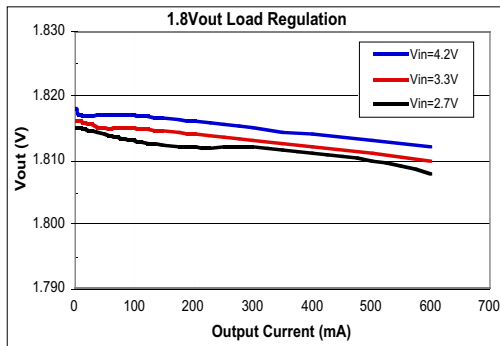

Figure 8: Load Regulation $V_{out} = 1.8V$

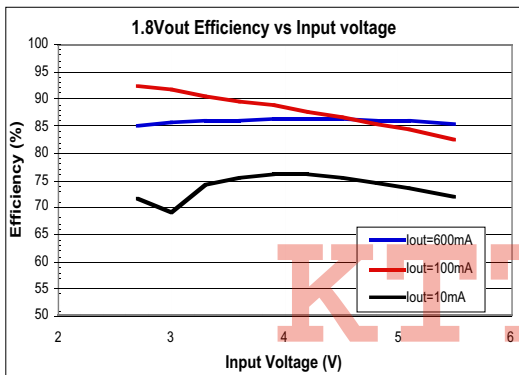

Figure 9: 1.8Vout Efficiency vs. Input Voltage

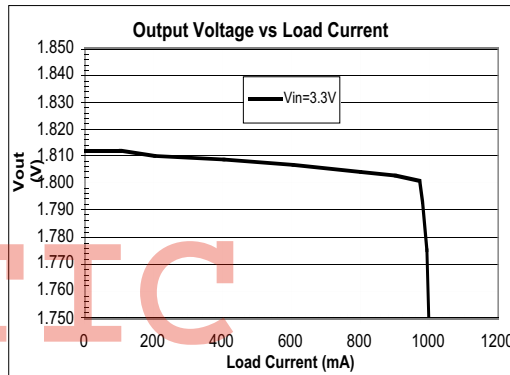

Figure 10: Output Voltage vs. Load Current

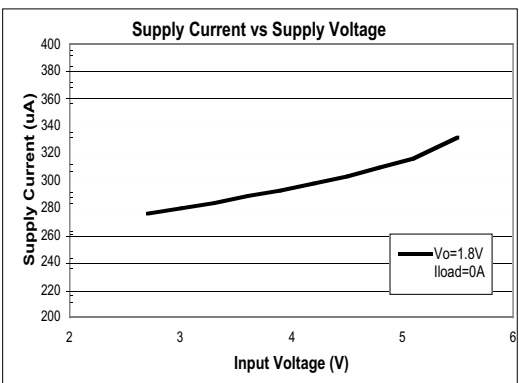

Figure 11: Supply Current vs. Supply Voltage

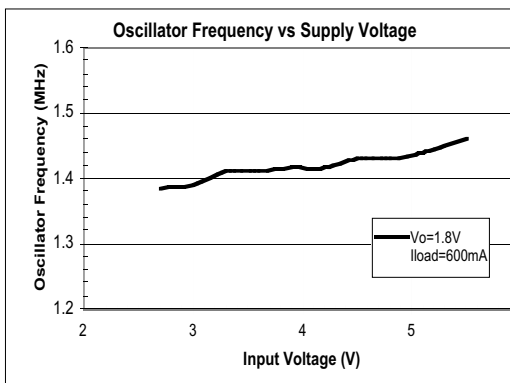

Figure 12: Oscillator Frequency vs. Supply Voltage

Refer to the typical application schematic, $V_{OUT} = 1.8V$, $T_{AMB} = +27^{\circ}C$

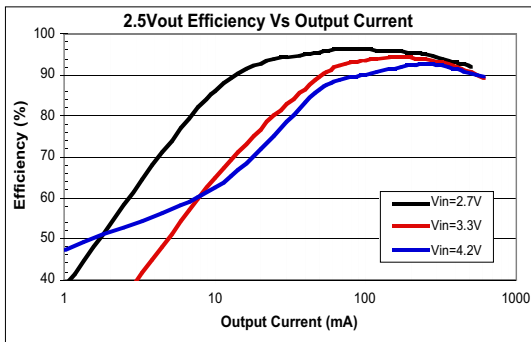

Figure 13: Efficiency Vs. Load Current, $V_{out} = 2.5V$

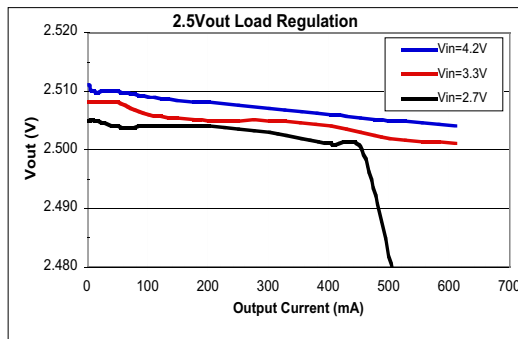

Figure 14: Load Regulation $V_{out} = 2.5V$

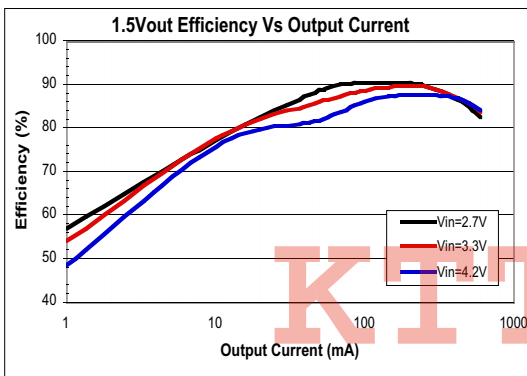

Figure 15: Efficiency Vs. Load Current, $V_{out} = 1.5V$

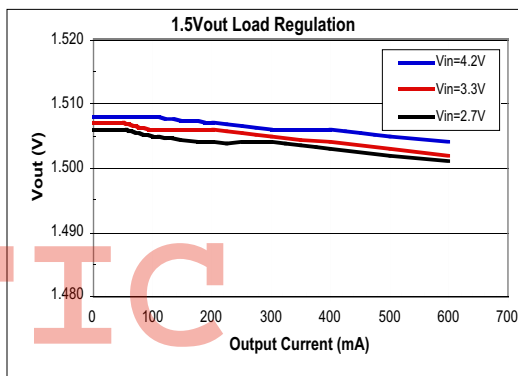

Figure 16: Load Regulation $V_{out} = 1.5V$

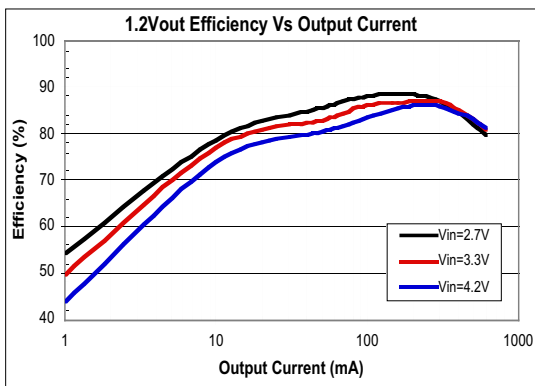

Figure 17: Efficiency Vs. Load Current, $V_{out} = 1.2V$

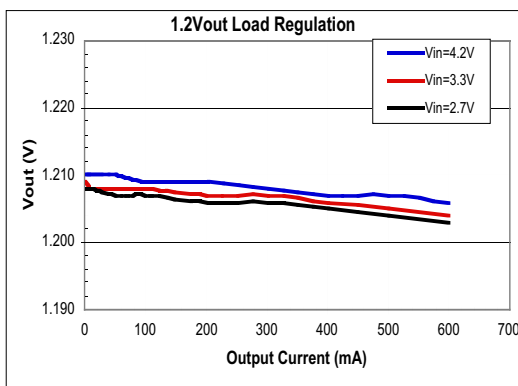
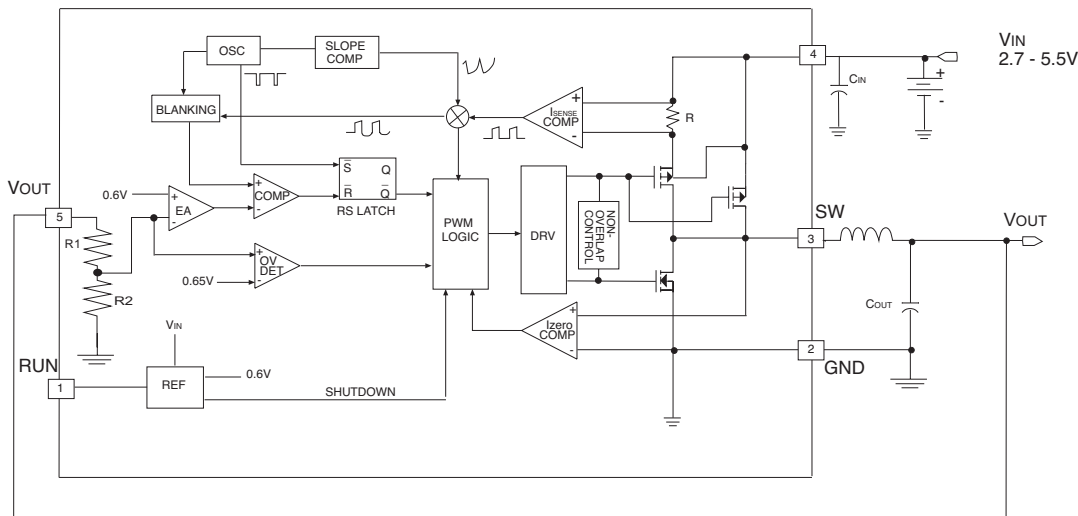
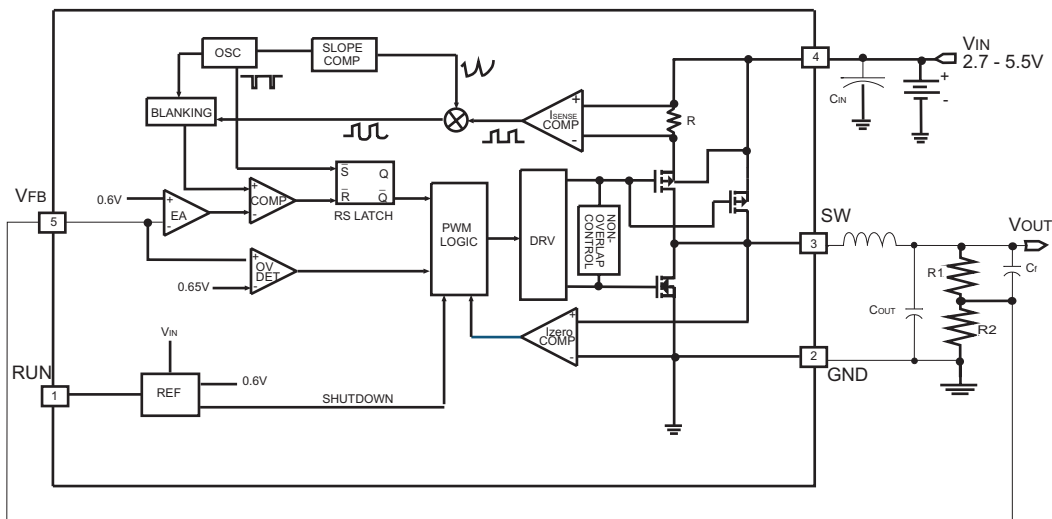

Figure 18: Load Regulation $V_{out} = 1.2V$



Fixed Output Version

KTTIC



Adjustable Output Version

SETTING THE OUTPUT VOLTAGE

A resistive divider based on the following equation determines the output voltage:

$$V_{OUT} = 0.6 \left(1 + \frac{R1}{R2} \right)$$

The external resistive divider is connected to the output as shown in Figure 20 .

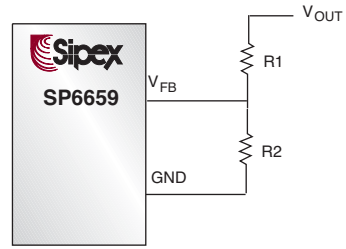
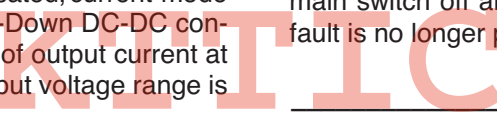

Figure 20: Setting the SP6659 Output Voltage.

THEORY OF OPERATION

The SP6659 is a monolithic switching mode Step-Down DC-DC converter. It utilizes internal MOSFETs to achieve high efficiency and can generate very low output voltage by using its internal reference at 0.6V. It operates at a fixed switching frequency, and uses slope compensated, current-mode architecture. This Step-Down DC-DC converter supplies 600mA of output current at $V_{IN} = 3V$. The entire input voltage range is from 2.5V to 5.5V.

on immediately and stay on until either the inductor current starts to reverse, as indicated by the current reversal comparator, I_{ZERO} , or the beginning of the next clock cycle. The OVDET comparator controls output transient overshoots by turning the main switch off and keeping it off until the fault is no longer present.



IDLE MODE OPERATION

CURRENT MODE PWM CONTROL

Slope compensated current mode PWM control provides stable switching and cycle-by-cycle current limit for excellent load and line responses and protection of the internal main switch (P-Channel MOSFET) as well as the synchronous rectifier (N-Channel MOSFET). During normal operation, the internal P-Channel MOSFET is turned on for a certain time to ramp the inductor current at each rising edge of the internal oscillator, and switched off when the peak inductor current is above the error voltage. The current comparator, I_{COMP} , limits the peak inductor current. When the main switch is off, the synchronous rectifier will be turned

At very light loads, the SP6659 automatically enters Idle Mode (Figure 21).

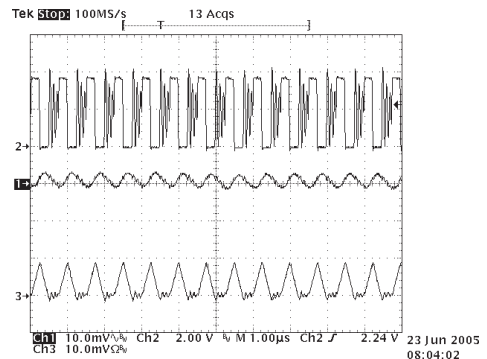

Figure 21. SP6659 Idle Mode Operation

In the Idle Mode, the inductor current may reach zero Amps or reverse on each pulse. The PWM control loop will automatically skip pulses to maintain output regulation. The bottom MOSFET is turned off by the current reversal comparator, I_{ZERO} , and the switch voltage will ring. This is the discontinuous mode of operation, and is normal behavior for the switching regulator.

DROPOUT OPERATION

When the input voltage decreases toward the value of the output voltage, the SP6659 allows the main switch to remain on for more than one switching cycle and increases the duty cycle until it reaches 100%.

The duty cycle D of a step-down converter is defined as:

$$D = T_{ON} \times f_{OSC} \times 100\% \\ \approx \frac{V_{OUT}}{V_{IN}} \times 100\%$$

where T_{ON} is the main switch on time, and f_{OSC} is the oscillator frequency (1.5Mhz).

The output voltage then is the input voltage minus the voltage drop across the main switch and the inductor. At low input supply voltages, the $R_{DS(ON)}$ of the P-Channel MOSFET increases, and the efficiency of the converter decreases. Caution must be exercised to ensure that the heat dissipated does not exceed the maximum junction temperature of the IC.

MAXIMUM LOAD CURRENT

The SP6659 will operate with an input supply voltage as low as 2.5V, however, the maximum load current decreases at lower inputs due to a large IR drop on the main switch and synchronous rectifier. The slope compensation signal reduces the peak inductor current as a function of the duty cycle to prevent sub-harmonic oscillations at duty cycles greater than 50%. Conversely, the current limit increases as the duty cycle decreases.

INDUCTOR SELECTION

For most designs, the SP6659 operates with inductors of $1\mu H$ to $4.7\mu H$. Low inductance values are physically smaller but require faster switching, which can result in some efficiency loss. The inductor value can be derived from the following equation:

$$L = \frac{V_{OUT} \times (V_{INMax} - V_{OUT})}{V_{INMax} \times \Delta I_L \times f_{OSC}}$$

Where ΔI_L is the inductor Ripple Current. Large value inductors lower ripple current and small value inductors result in higher ripple current. Choose inductors at ripple current of approximately 35% of the maximum load current 600mA, or $\sim 210mA$.

For output voltages above 2.0V, when light-load efficiency is important, the minimum recommended inductor is $2.2\mu H$. For optimum voltage-positioning load transients,

choose an inductor with DC series resistance in the 50mΩ to 150mΩ range. For higher efficiency at heavy loads (above 200mA), or minimal load regulation (but some transient overshoot), the resistance should be kept below 100mΩ. The DC current rating of the inductor should be at least equal to the maximum load current plus half the ripple current to prevent core saturation (600mA+105mA).

Table 1 lists some typical surface mount inductors that meet target applications for the SP6659.

SP6659 Inductor Selection Chart

Part #	Inductor (μH)	Max DCR (mΩ)	Rated DC Current (Amps)	Size WxLxH (mm)
Murata LQH32CN2R2M11	1.0	78	1	3.2x2.5x1.55
Murata LQH32CN2R2M11	2.2	126	0.79	3.2x2.5x1.55
Murata LQH32CN4R7M11	4.7	195	0.65	3.2x2.5x1.55
Sumida CR43	1.4	56.2	2.52	4.5x4.0x3.5
	2.2	71.2	1.5	
	3.3	86.2	1.44	
	4.7	108.7	1.15	
Sumida CDRH4D18	1.5			4.7x4.7x2.0
	2.2	75	1.32	
	3.3	110	1.04	
	4.7	162	0.84	
Toko D312C	1.5	120	1.29	3.6x3.6x1.2
	2.2	140	1.14	
	3.3	180	0.98	
	4.7	240	0.79	

Inductor in **Bold** is used on the SP6659EB evaluation Board

Table 1: Typical Surface Mount Inductors

INPUT CAPACITOR SELECTION

The input capacitor reduces the surge current drawn from the input and switching noise from the device. The input capacitor impedance at the switching frequency shall be less than input source impedance to prevent high frequency switching current from passing to the input. A low ESR (Equivalent Series Resistance) input capacitor sized for maximum RMS current must be used. Ceramic capacitors with X5R or X7R dielectrics are highly recommended because of their low ESR and small temperature coefficients. A 4.7μF ceramic capacitor for most applications is sufficient.

OUTPUT CAPACITOR SELECTION

The output capacitor is required to keep the output voltage ripple small and to ensure regulation loop stability. The output capacitor must have low impedance at the switching frequency. Ceramic capacitors with X5R or X7R dielectrics are recommended due to their low ESR and high ripple current. The output ripple ΔV_{OUT} is determined by:

$$\Delta V_{OUT} \leq$$

$$\frac{V_{OUT} \times (V_{INMax} - V_{OUT})}{V_{INMax} \times L \times f_{osc}} \times \left\{ ESR + \frac{1}{(8 \times f_{osc} \times C_{OUT})} \right\}$$

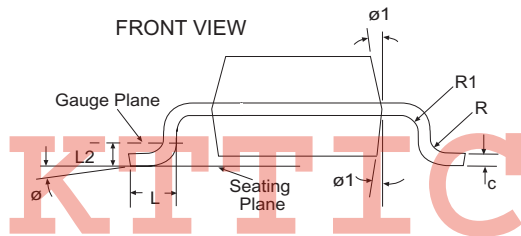
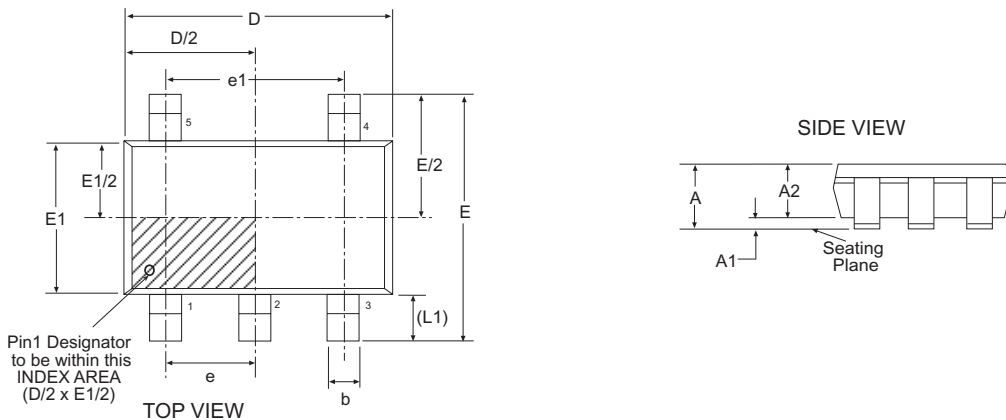

5 Pin TSOT-23		JEDEC MO-193		Variation AB		
SYMBOL	Dimensions in Millimeters: Controlling Dimension			Dimensions in Inches Conversion Factor: 1 Inch = 25.40 mm		
	MIN	NOM	MAX	MIN	NOM	MAX
A	-	-	1.10	-	-	0.043
A1	0.00	-	0.10	0.000	-	0.004
A2	0.70	0.90	1.00	0.028	0.036	0.039
c	0.08	-	0.20	0.003	-	0.008
D	2.90 BSC			0.114 BSC		
E	2.80 BSC			0.110 BSC		
E1	1.60 BSC			0.063 BSC		
L	0.30	0.45	0.60	0.012	0.018	0.024
L1	0.60 REF			0.024 REF		
L2	0.25 BSC			0.010 BSC		
Ø	0°	4°	8°	0°	4°	8°
Ø1	4°	10°	12°	4°	10°	12°
R	0.10	-	-	0.004	-	-
R1	0.10	-	0.25	0.004	-	0.010
b	0.30	-	0.50	0.012	-	0.020
e	0.95 BSC			0.038 BSC		
e1	1.90 BSC			0.075 BSC		
SIPEX Pkg Signoff Date/Rev:				JL Aug4-05 / Rev A		

Part Number	Operating Temperature Range	Package Type
SP6659EK1	-40°C to +85°C	5 Pin TSOT23
SP6659EK1/TR	-40°C to +85°C	5 Pin TSOT23
SP6659EK1-1-5	-40°C to +85°C	5 Pin TSOT23
SP6659EK1-1-5/TR	-40°C to +85°C	5 Pin TSOT23
SP6659EK1-1-8	-40°C to +85°C	5 Pin TSOT23
SP6659EK1-1-8/TR	-40°C to +85°C	5 Pin TSOT23

Available in lead free packaging. To order add "-L" suffix to part number.

Example: SP6659EK1/TR = standard; SP6659EK1-L/TR = lead free

/TR = Tape and Reel

Pack quantity is 2,500 for TSOT23.



Sipex Corporation
Headquarters and Sales Office
 233 South Hillview Drive
 Milpitas, CA 95035
 TEL: (408) 934-7500
 FAX: (408) 935-7600

Sipex Corporation reserves the right to make changes to any products described herein. Sipex does not assume any liability arising out of the application or use of any product or circuit described herein; neither does it convey any license under its patent rights nor the rights of others.