

ABSOLUTE MAXIMUM RATINGS

Symbol	Parameter	Conditions	Ratings	Unit
HGND	High Side Floating Supply Offset Voltage		600	V
HVCC	High Side Floating Supply Voltage	HGND=GND	-0.5~+20	V
VCC	Low Side Fixed Supply Voltage		-0.5~+20	V
VOV	OV Input Voltage		-0.5 ~ VCC+0.5	V
VAB	AB Input Voltage		-0.5 ~ VCC+1.0	V
IAB	AB Input Current		2	mA
VABTH	ABTH Input Voltage		-0.5 ~ VCC+0.5	V
VLN	LN Input Voltage		-0.5 ~ VCC+1.0	V
ILN	LN Input Current		2	mA
VLNTH	LNTH Input Voltage		-0.5 ~ VCC+0.5	V
VVCO	VCO Input Voltage		-0.5 ~ VCC+0.5	V
IHO	High Side Output Current		±500	mA
ILO	Low Side Output Current		±500	mA
Pt	Package Power Dissipation	Ta = 25°C, On Board	1.56	W
K θ	Linear Derating Factor	Ta > 25°C, On Board	12.5	mW/°C
Rth(j-c)	Junction-Case Thermal Resistance		25	°C/W
Tj	Junction Temperature		150	°C
Topr	Operation Temperature		-20 ~ +80	°C
Tstg	Storage Temperature		-40 ~ +125	°C

ELECTRICAL CHARACTERISTICS (Ta=25°C, GND=HGND, VCC=HVCC=15V, unless otherwise specified)

Symbol	Parameter	Test conditions	Limits			Unit
			Min.	Typ.	Max.	
HVCC	High Side Floating Supply Voltage	HVCC-HGND	13	15	17	V
VCC	Low Side Fixed Supply Voltage		13	15	17	V
VREG	Internal Supply Voltage	VCC=15V, NO Load	6.9	7.2	7.5	V
ICC1	Standby Current	VCC=15V, CNT=5V, OV=5V	—	0.75	1.0	mA
ICC2	ON Suspension Oscillate Current	VCC=15V, CNT=0V	—	2.0	4.0	mA
ICC3	ON Oscillation Current (50Hz)	VCC=15V, RVC01=15kΩ, VVCO=0.33VREG	2.0	5.0	8.0	mA
ICC4	ON Oscillation Current (115kHz)	RVC02=39kΩ, CVCO=100pF, VVCO=0.42VREG	2.0	8	12	mA
VUVr	VCC UV Reset Voltage		9.0	10	11	V
VUVt	VCC UV Trip Voltage		5.5	6.5	7.5	V
tUV	VCC Supply UV Filter Time		14	—	100	μs
VOV	OV Protection Vth		3.4	3.6	3.8	V
tOV	OV Filter Time		30	—	150	μs
IOV	OV Input Leak Current	VOV=0V	-0.5	-0.08	—	μA
fVCO	VCO Frequency Set Up Limit		—	—	250	kHz
fO	Output Frequency Set Up Limit	LO, HO	—	—	125	kHz
VVCO	VCO Input Voltage Limit		1.5	—	VREG-1.5	V
IVCO	VCO Input Leak Current	VVCO=0V	-2	-0.66	—	μA
VCVCO	CVCO Input Voltage	VREG=7.2V	5.5	5.55	5.6	V
ICVCO	CVCO Input Leak Current	VCVCO=0V, VVCO >VCVCO	-2	-0.66	—	μA
IrRVCO	RVCO Leak Current	VCVCO=0V, VREG=7.2V, VRVCO=10V	—	—	0.5	μA
VSrvCO	RVCO Saturation Voltage	VCVCO=6V, VREG=7.2V, IRVCO=10mA	—	—	500	mV

HIGH VOLTAGE HALF BRIDGE DRIVER

ELECTRICAL CHARACTERISTICS (Ta=25°C, GND=HGND, VCC=HVCC=15V, unless otherwise specified)

Symbol	Parameter	Test conditions	Limits			Unit
			Min.	Typ.	Max.	
VLN	LN Input Voltage Limit		1.0	—	VCC-1.5	V
VLNTH	LNTH Input Voltage Limit		1.0	—	VCC-1.5	V
VLNIO	LN Offset Voltage		-50	—	50	mV
ILN	LN Input Leak Current	VLN>VLNTH	-1	-0.22	—	μA
ILNTH	LNTH Input Leak Current	VLN>VLNTH, VCC<VUVr	-1	-0.22	—	μA
ILNTHh	LNTH Input Hysteresis Current	VLN > VLNTH, VLNTH=5V	20	40	80	μA
tLN	LN Filter Time		14	—	100	μs
VAB	AB Input Voltage Limit		0	—	VREG-1.5	V
VABTH	ABTH Input Voltage Limit		0	—	VREG-1.5	V
VABIO	AB Offset Voltage		-50	—	50	mV
IAB	AB Input Leak Current	VAB<VABTH	-0.5	-0.08	—	μA
IABTH	ABTH Input Leak Current	VAB>VABTH	-0.5	-0.08	—	μA
tAB	AB Filter Time		30	—	150	μs
VCNT	CNT Input Threshold Voltage		3.4	3.6	3.8	V
VCNTth	CNT Input Hysteresis Voltage		0.8	1.0	1.2	V
ICNT	CNT Input Leak Current	VCNT=0V	-0.5	-0.08	—	μA
tCNT	CNT Filter Time		30	—	150	μs
IRFC	Floating Supply Leak Current	VHGND=600V	—	—	1.0	μA
tDEAD	Dead Time	C=1000pF	1.0	—	1.9	μs
VHOH1	HO Output Voltage	IHO=0mA	14	14.4	—	V
VHOH2		IHO=-20mA	10	13	—	V
VHOH3		IHO=-200mA	1.0	5.5	—	V
VHOL1		IHO=0mA	—	5	100	mV
VHOL2		IHO=20mA	—	0.5	1.0	V
VHOL3		IHO=200mA	—	6	12	V
VLOH1	LO Output Voltage	ILO=0mA	14	14.4	—	V
VLOH2		ILO=-20mA	10	13	—	V
VLOH3		ILO=-200mA	1.0	5.5	—	V
VLLO1		ILO=0mA	—	5	100	mV
VLLO2		ILO=20mA	—	0.5	1.0	V
VLLO3		ILO=200mA	—	6	12	V
tr	Output Rise Time	Amplitude 10% → 90%, C=1000pF	—	50	120	ns
tf	Output Fall Time	Amplitude 90% → 10%, C=1000pF	—	50	120	ns

OUTPUT FREQUENCY (RVCO1=15kΩ, RVCO2=15kΩ, CVCO=100pF)

Oscillation Frequency	VCO Input Voltage	Min.	Typ.	Max.	Unit
50kHz	0.33VREG	—	50	—	kHz
60kHz	0.42VREG	—	60	—	kHz

DEAD TIME

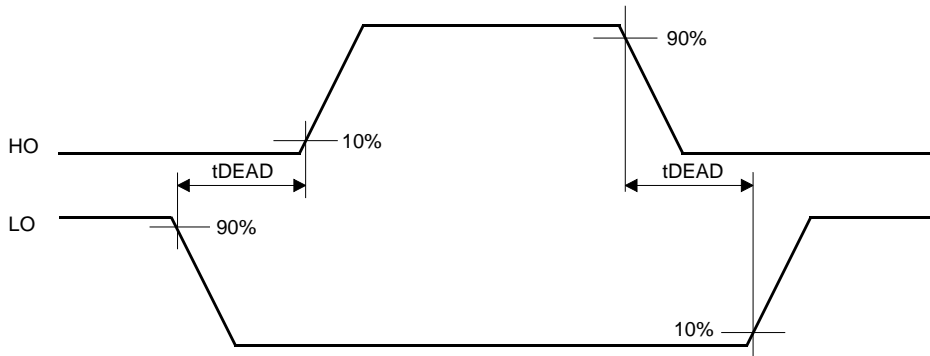

**OUTPUT RISE TIME
FALL TIME**

KTTIC

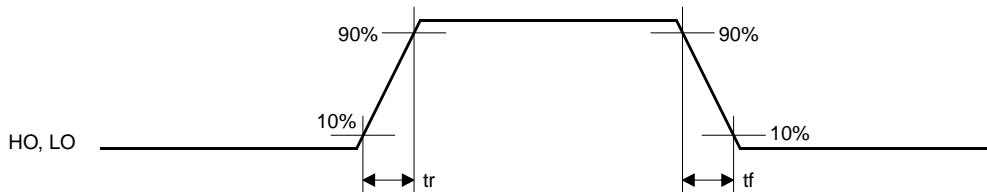

HIGH VOLTAGE HALF BRIDGE DRIVER

PERFORMANCE CURVES

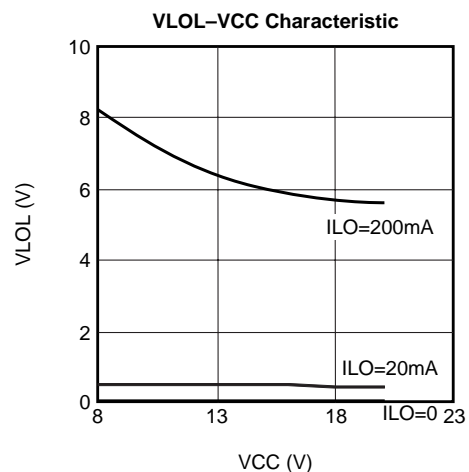
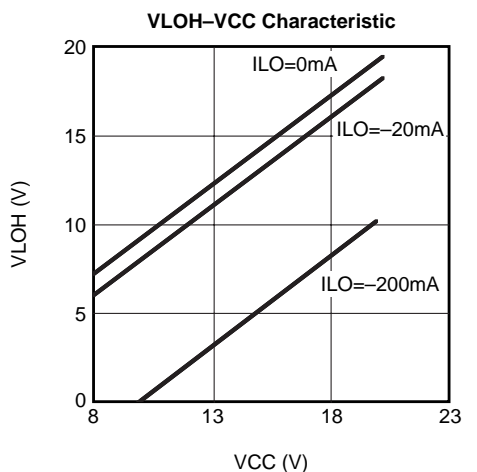
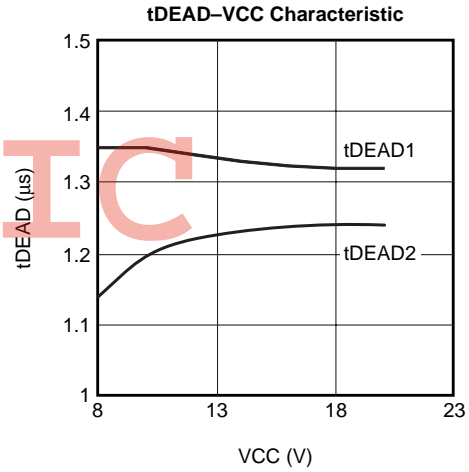
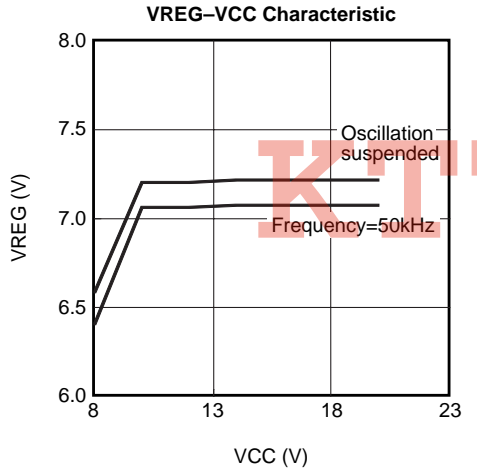
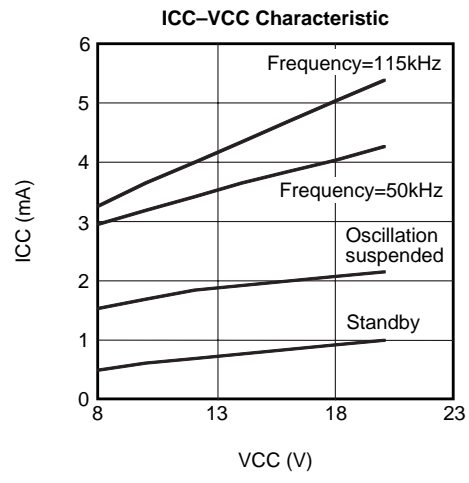
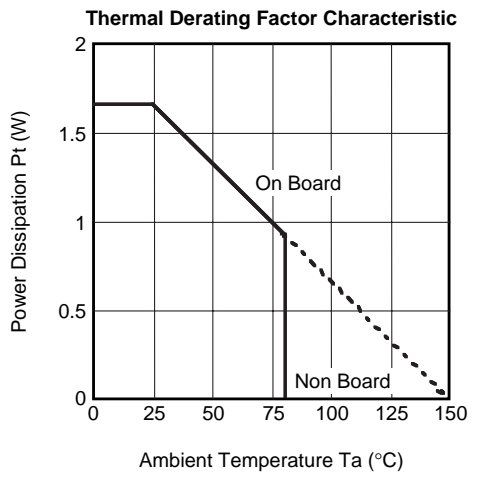

HIGH VOLTAGE HALF BRIDGE DRIVER

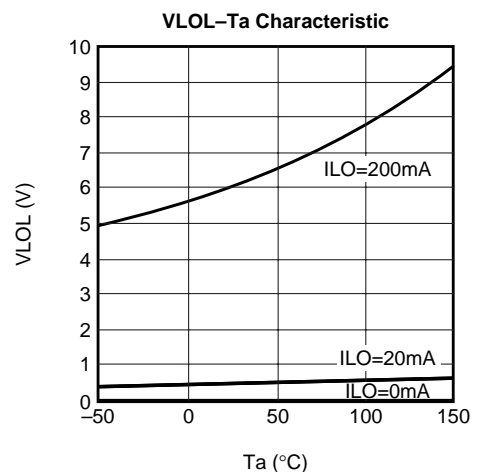
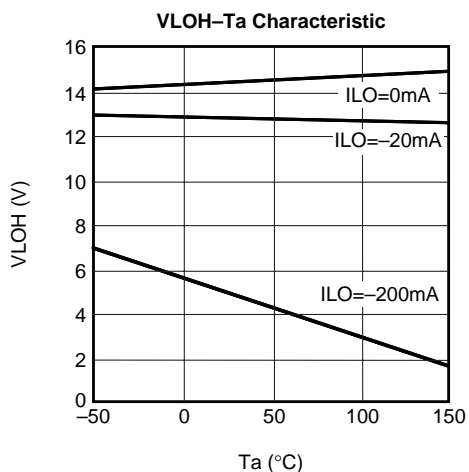
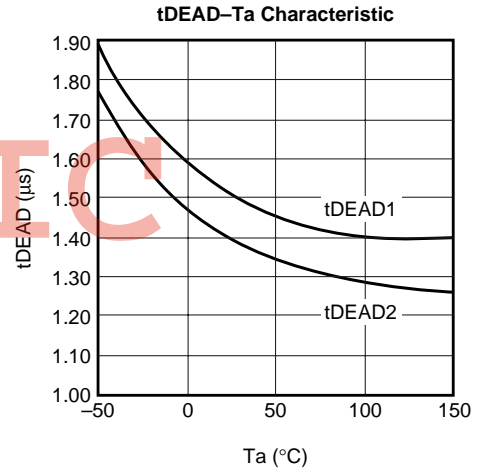
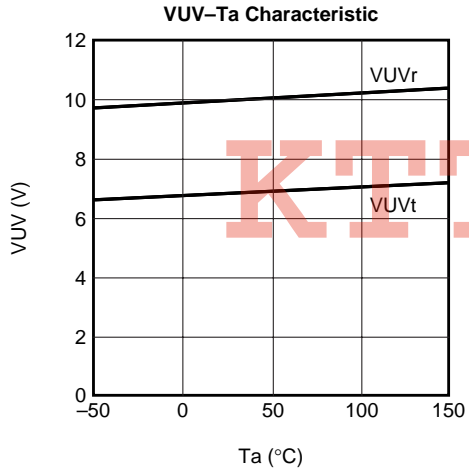
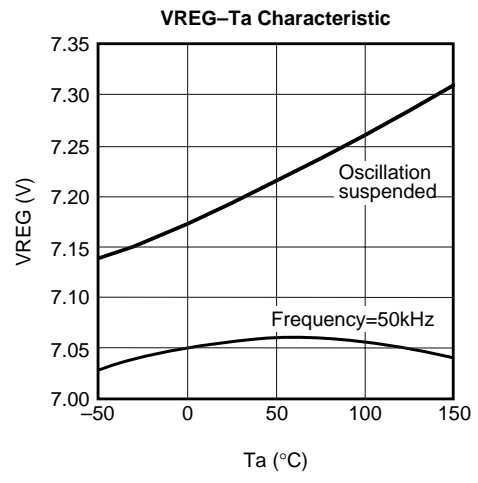
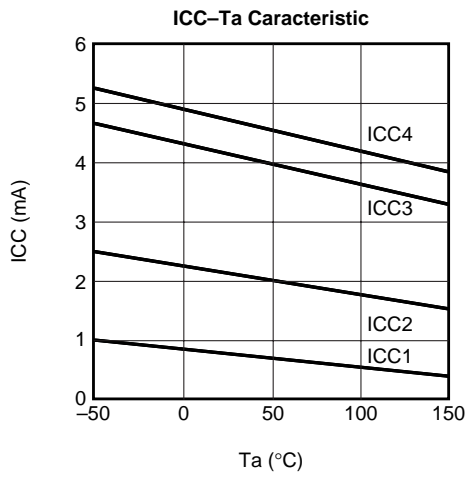

PACKAGE OUTLINE

16P4

Plastic 16pin 300mil DIP

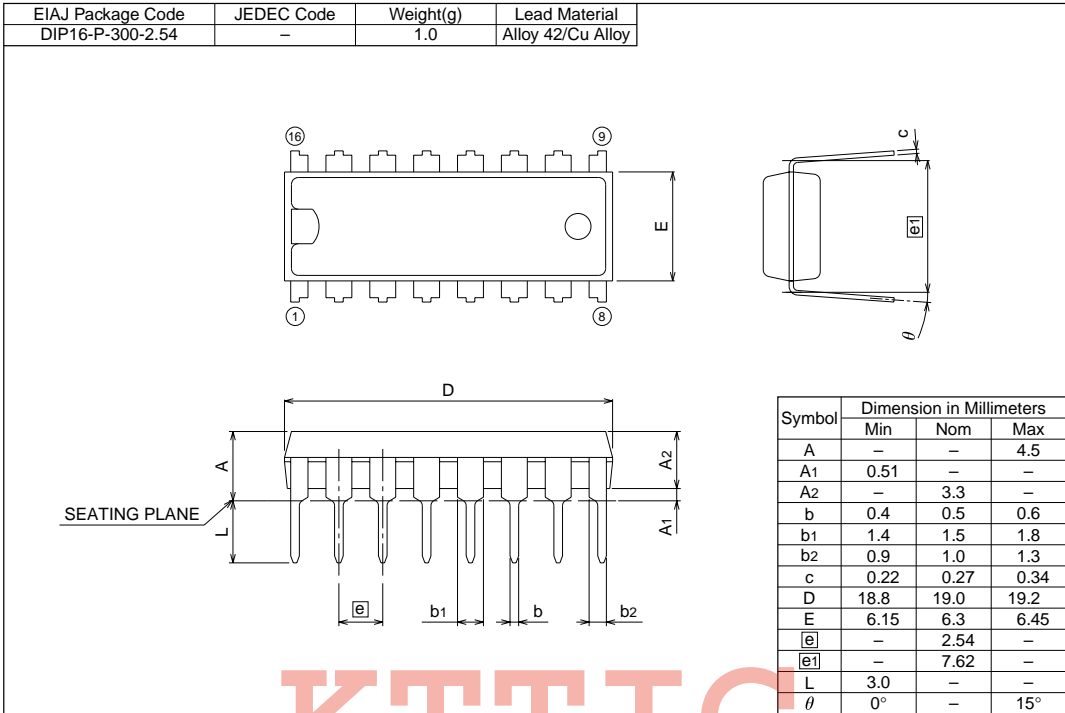

KTTIC